

	User & Installation manual VHF- Communication Transceiver	Doc.-Nr.: DE-3000-800100e
	KRT2, KRT2M, KRT2RC	Revision 13.0 Jul. 2016

KRT2, KRT2"Mini", KRT2RC VHF Communication Transceiver





P/N 100-(0XXX)-() KRT2
P/N 100-(1XXX)-() KRT2MH
P/N 100-(2XXX)-() KRT2MV
P/N 110-()-() KRT2RC

Operation and Installation Manual

	User & Installation manual VHF- Communication Transceiver	Doc.-Nr.: DE-3000-800100e
	KRT2, KRT2M, KRT2RC	Revision 13.0 Jul. 2016

Record of Revisions

Revision	Date	Subject
1	06 Juni 2010	First issue
2	20 Sep 2010	Revision Stecker / Redaktionelle Änderungen
3	05 Feb 2011	Editorial update
4	04 Mai 2012	Cable-harness correction
5	16 Mai 2012	Software advantage for battery indication, error reports
6	19.Aug 2012	Hints for mic. Installation & intercom
7	Sept. 2012	Correction wiring
8	Dec. 2012	Dynamic Microphone GND-wiring
8.1, 8,2	Feb.2013	Text corrections
9	March 2013	Additional drawing, clarify microphone GND
9.1	March 2013	Text corrections
9.2	April 2013	Hints in drawings
9.3	Aug. 2013	Text corrections, new cable drawings
9.4	Okt. 2013	Text corrections
9.5	Nov. 2013	New favorites management
9.6	Mai 2014	Menu-limitation, PTT-Mic.-assignment, Installation limitations, Text corrections, Mic.-AUTO-enhancement
9.7	Jun 2014	Hint for speaker installation
9.8	July 2014	Add chapter 6.6.2 and 6.8.3.1, add drawing motor glider
9.9	Nov 2014	Update Installation and Limitations Section.
10.0	Dec. 2014	New Display
11.0	May 2015	Specialty of two PTT
11.1	Jun 2015	Recommendation for SIT
11.2	July 2015	6.8.3.2 Schematic correction (TX/RX)
11.3	Aug 2015	6.6.5 Supplement for speaker grounding
11.4	Sept 2015	4.4.2 Squelch explain
12.0	Oct. 2015	Extension for Mini & Portrait
13.0	July 2016	Updated part number and added EASA approval number. Included KRT2 Mini and Remote Control information. Included TQ references for customer support. Improvement of Self-Testing Diagnose Code

	User & Installation manual VHF- Communication Transceiver	Doc.-Nr.: DE-3000-800100e
	KRT2, KRT2M, KRT2RC	Revision 13.0 Jul. 2016

List of Service-Bulletins (SB)

Service-Bulletins have to be inserted in the manual, and entered in the table.				
SB Number	Rev. No.	Date Issued	Date Inserted	Name

Unit overview

Item No.	Product Overview
	Basic Version
	Introduction of: <ul style="list-style-type: none"> • 2 Standard Microphone Inputs • Auxiliary Audio Input • DUAL Watch Function





	User & Installation manual VHF- Communication Transceiver	Doc.-Nr.: DE-3000-800100e
	KRT2, KRT2M, KRT2RC	Revision 13.0 Jul. 2016

TABLE OF CONTENTS

1	GENERAL	7
1.1	Symbols	7
1.2	Acronyms	8
1.3	Customer Service	9
1.4	KRT2 Transceiver properties	9
2	Installation limitation	10
2.1	Installation	10
2.2	Aircraft Radio	10
2.3	Quantitative Safety Objective Identification	11
2.4	Deviations	11
3	CONTROL general	12
3.1	Control Elements Overview	12
3.2	Display	15
3.3	Menu levels	16
3.4	Self-test error reports	17
4	OPERATION	18
4.1	General	18
4.2	ON / OFF Switching	18
4.3	Frequency Selection	19
4.3.1	Direct Frequency Selection	19
4.3.2	Frequency Selection from the Favorites List	20
4.3.3	Storing and Editing Favorites	20
4.4	AUD – Audio Menu	23
4.4.1	VOL – Volume	23
4.4.2	SQ – Squelch	23
4.4.3	VOX – Intercom Voice Trigger Level Setting	24
4.4.4	Manual Intercom	24
4.4.5	TXm – PTT Switch Selection	25
4.4.6	INT – Intercom Volume	25
4.4.7	EXT – External Audio Input Volume	25
4.4.8	DIM – Display Brightness	26
4.4.9	BAT – Battery Test	26
4.4.10	SIT – Side tone	27
4.4.11	MIC – Setup	27
4.4.12	Menu lock	30
4.5	DUAL Watch	31
4.6	Transmitter Operation	33
4.6.1	Two PTT Configuration	34
4.6.2	Self-Test monitor	34
4.6.3	Optical side tone	35
4.7	Resetting to factory settings	36
4.8	SET UP - Menu	36
4.8.1	ERASE – Erasing the Favorites List	37
4.8.2	Channel Spacing	37
5	Remote Control	38
6	Installation	39
6.1	Installation Hints	39
6.2	Telecommunication Data	40
6.3	Scope of delivery	40
6.4	Unpacking and Inspecting the Equipment	41
6.5	Mounting	41

	User & Installation manual VHF- Communication Transceiver	Doc.-Nr.: DE-3000-800100e
	KRT2, KRT2M, KRT2RC	Revision 13.0 Jul. 2016

6.6	Electrical Connections	42
6.6.1	Microphone-Connection.....	42
6.6.2	Speaker & open microphone:	44
6.6.3	Earphone Connection	44
6.6.4	External Audio Input	44
6.6.5	Speaker Connection	44
6.7	Final Audio-Setup	45
6.7.1	For glider flights	45
6.7.2	For motor gliders dual seaters	46
6.7.3	For Motor planes.....	46
6.8	Wiring.....	47
6.8.1	Wire Gauges.....	47
6.8.2	Connector Pin-Configuration	47
6.8.3	General hint	48
6.8.4	Wiring Diagram	49
6.8.4.1	Two place motor aircraft connection.....	49
6.8.4.2	Glider two place connection.....	50
6.8.4.3	Glider single	51
6.8.4.4	Motor glider single	52
6.8.4.5	Motor glider dual-Dynamic Microphone.....	53
6.8.4.6	Motor glider dual-Electret Microphone.....	54
6.8.5	Wiring for dynamic microphones	55
6.8.6	Connection support.....	55
6.9	Antenna.....	56
6.9.1	Antenna Selection.....	56
6.9.2	Installation Recommendation	56
6.10	Microphone general	57
6.11	Post-Installation Check	58
6.12	Starting Up	58
6.13	Accessories.....	59
6.14	Drawings	60
6.14.1	Dimensions	60
6.14.2	Installation Directions.....	62
7	Maintenance.....	63
7.1	Periodic Maintenance	63
7.2	Repair	63
7.3	Cleaning.....	63
8	ANNEX.....	64
8.1	Frequency / Channel- schedule.....	64
8.2	Technical Data.....	65





	User & Installation manual VHF- Communication Transceiver	Doc.-Nr.: DE-3000-800100e
	KRT2, KRT2M, KRT2RC	Revision 13.0 Jul. 2016

Table of Figures

Figure 1: Acronyms.....	8
Figure 2: KRT2 Front view.....	12
Figure 3: KRT2Mini Front view	13
Figure 4: KRT2 Controls	14
Figure 5: KRT2 Display.....	16
Figure 6: KRT2 Menu Levels.....	16
Figure 7: KRT2 Built In Tests (BIT)	17
Figure 8: KRT2 Menu Lock.....	30
Figure 9: KRT2 Active & Standby frequencies	32
Figure 10: KRT2 TX & RX operations	33
Figure 11: Telecommunication data	40
Figure 12: Small parts.....	40
Figure 13: Head sets	43
Figure 14: Connector pin out	47
Figure 15: Remote control pin out	48
Figure 16: KRT2 Connection support	55
Figure 17: KRT2 Dimensions	60
Figure 18: KRT2M "Mini" Dimensions	60
Figure 19: KRT2RC Remote Control Dimensions	61
Figure 20: KRT2 Panel Cut out	62
Figure 21: KRT2M "Mini" Panel Cut out	62
Figure 22: Frequencies.....	64
Figure 23: Technical Data	66
Figure 24: Transmitter/Receiver	67

	User & Installation manual VHF- Communication Transceiver	Doc.-Nr.: DE-3000-800100e
	KRT2, KRT2M, KRT2RC	Revision 13.0 Jul. 2016

1 GENERAL



This manual contains information about the physical, mechanical and electrical properties as well as a description for the operation and installation of the VHF airborne transceiver KRT2.

1.1 Symbols

	WARNING Non-compliance may cause personnel injury due to radiation or fire.
---	---

	CAUTION Non-compliance may cause damage or incorrect operation of the transceiver.
---	--



	INFORMATION
---	--------------------

	User & Installation manual VHF- Communication Transceiver	Doc.-Nr.: DE-3000-800100e
	KRT2, KRT2M, KRT2RC	Revision 13.0 Jul. 2016

1.2 Acronyms

Abb	Description	Definition
BAT	Battery	Check DC source
DIM	Dimming	Display brightness setting
EXT	External audio input	External Audio input level setting
INT	Intercom level	Intercom volume level setting
PTT	Push to Talk	Transmitter activation
RC	Remote Control	The KRT2Rc is the KRT2 remote control.
SQ	Squelch	Squelch setting
VOX	Voice operated intercom	Voice level setting for intercom activation

Figure 1: Acronyms

	User & Installation manual VHF- Communication Transceiver	Doc.-Nr.: DE-3000-800100e
	KRT2, KRT2M, KRT2RC	Revision 13.0 Jul. 2016

1.3 Customer Service

In order to process returned units most expeditiously, please use the email support.krt@tq-group.com on the website <http://www.dittel-avionik.de/de/content/support>.



	Suggestions which will improve this manual are very much appreciated at: info.dittel@tq-group.com .
---	---

	Information concerning software updates is available under support.krt@tq-group.com .
---	---

1.4 KRT2 Transceiver properties

- VHF airborne transceiver
- Frequency range 118,000 to 136,975 MHz
- Channel spacing 8,33/25 kHz (2278 channel)
- Fast channel selection
- 4 separate microphone inputs (2 x standard or 2 x dynamics)
- Audio-input for other audio devices
- Installation: Standard panel cut-out (57 mm)
- 100 user definable frequencies with up to 8 character identifiers

	Continuous transmissions will be turned off after 2 minutes. (Stuck microphone function)
---	--

	User & Installation manual VHF- Communication Transceiver	Doc.-Nr.: DE-3000-800100e
	KRT2, KRT2M, KRT2RC	Revision 13.0 Jul. 2016

2 Installation limitation

The conditions and tests required for (E)TSO approval of this article are minimum performance standards. It is the responsibility of those installing this article either on or within a specific type or class of aircraft to determine that the aircraft installation conditions are within the (E)TSO standards. (E)TSO articles must have separate approval for installation in aircraft.

2.1 Installation

For installation hints, data, electrical connections and mounting instructions please see section “6 Installation”.

2.2 Aircraft Radio

The KRT2 was designed as a closed unit for installation in a cockpit environment of the general aviation with the following limitations:



Installation must be in accordance with the applicable EASA or FAA requirements.

The classification of the software approval is suitable for aircraft type. The failure classification identified in accordance with FAA AC 23.1309-1D is:

MINOR

The Software level is:

LEVEL D



	User & Installation manual VHF- Communication Transceiver	Doc.-Nr.: DE-3000-800100e
	KRT2, KRT2M, KRT2RC	Revision 13.0 Jul. 2016

2.3 Quantitative Safety Objective Identification

In accordance with EASA regulations, the goal is a safety objective for the VHF COM radio in the KRT-2 VHF Communication Transceiver System of $1 \times 10E-4$ per flight hour for Class I Airplanes and $1 \times 10E-5$ per flight hour for Class II Airplanes.

2.4 Deviations

Deviation “DE-3000-800001” has been granted by the EASA (Use DO160F instead of DO160E).

	User & Installation manual VHF- Communication Transceiver	Doc.-Nr.: DE-3000-800100e
	KRT2, KRT2M, KRT2RC	Revision 13.0 Jul. 2016

3 CONTROL general

3.1 Control Elements Overview

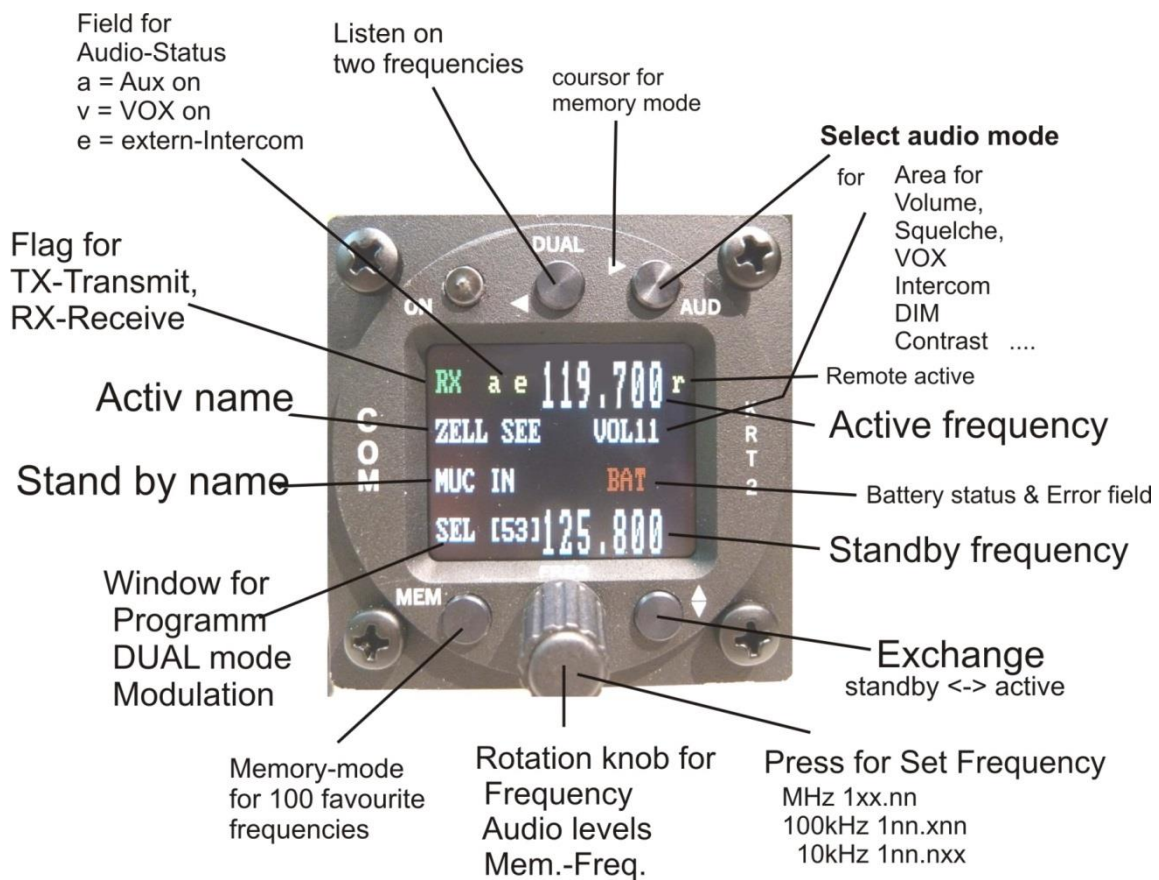



Figure 2: KRT2 Front view

	User & Installation manual VHF- Communication Transceiver	Doc.-Nr.: DE-3000-800100e
	KRT2, KRT2M, KRT2RC	Revision 13.0 Jul. 2016

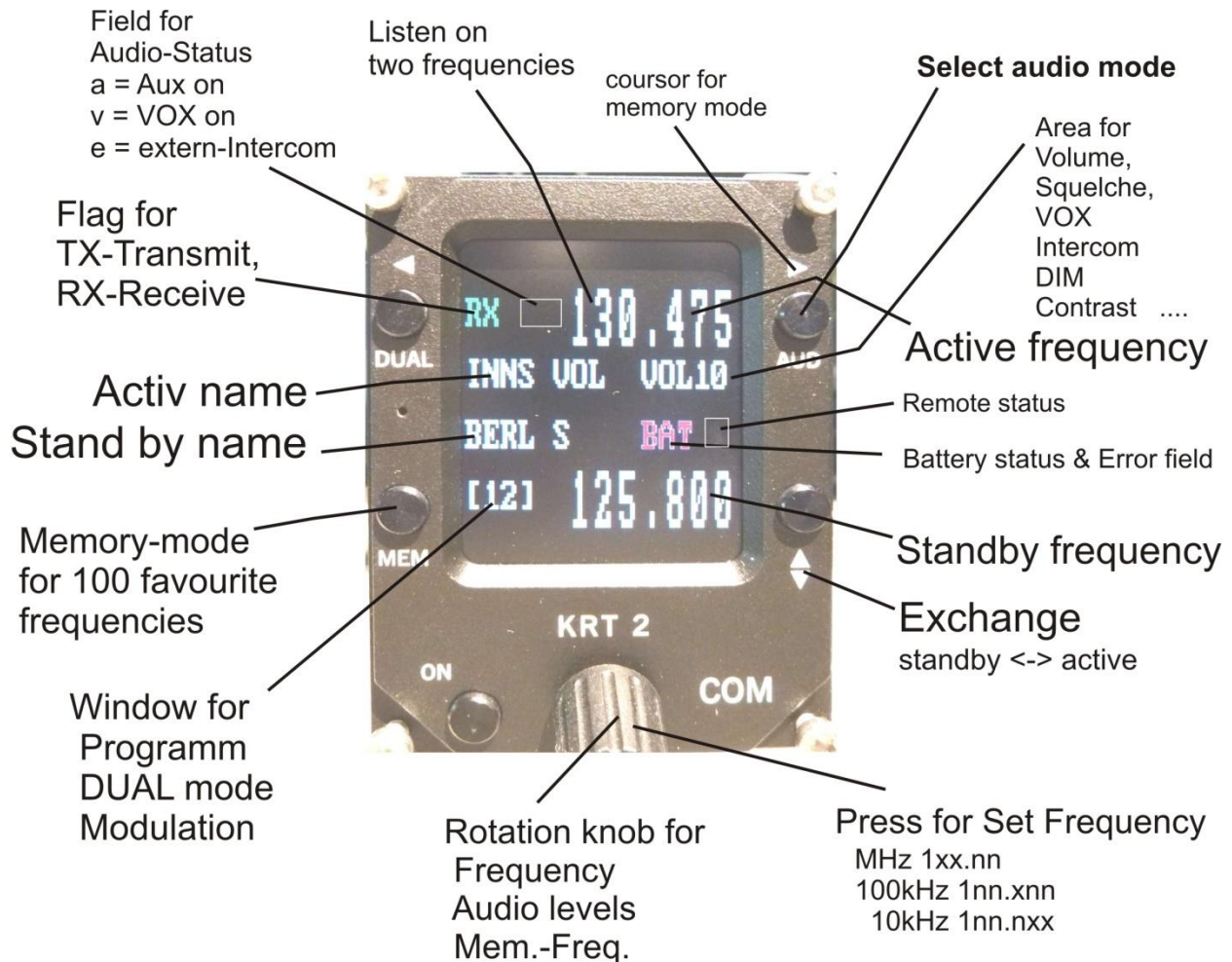



Figure 3: KRT2Mini Front view

All functions and performances of the normal size unit (57mm round) and the Portrait format (Mini) are identical.

The only differences are the text areas on the display Compare Figure 2: KRT2 Front view and Figure 3: KRT2Mini Front view for more details.

	User & Installation manual VHF- Communication Transceiver	Doc.-Nr.: DE-3000-800100e
	KRT2, KRT2M, KRT2RC	Revision 13.0 Jul. 2016









Button	Function	Usage
	ON / OFF	Self-locking switch
	DUAL WATCH	<ol style="list-style-type: none"> 1. Scanning between the Active and Standby frequencies 2. Positioning cursor to the left when programming the station identifier
	AUDIO SELECT	<ol style="list-style-type: none"> 1. Stepping through the audio menus VOL SQ VOX TX INT EXT DIM CON SIT and MIC 2. Positioning cursor to the right when programming the station identifier
	FAVORITES	<ol style="list-style-type: none"> 1. Frequency and identifier selection from the favorites list 2. Programming of favorites (frequency and identifier)
	EXCHANGE	Exchange of the Active and Standby frequencies
	TURNING KNOB	<p>Pressing for Selection of the frequency range to: MHz, 100kHz, 10kHz Toggles between frequency and identifier when programming the favorites</p> <p>Sets all variable values in any menu</p> <ol style="list-style-type: none"> 1. Volume setting of headsets and speakers 2. MHz/kHz selection of the standby frequency in 3 different ranges 3. Favorite selection 4. Alpha character selection when programming favorites 5. Change of microphone settings

Figure 4: KRT2 Controls

	User & Installation manual VHF- Communication Transceiver	Doc.-Nr.: DE-3000-800100e
	KRT2, KRT2M, KRT2RC	Revision 13.0 Jul. 2016

3.2 Display

Indication	Meaning	Remarks
RX	Reception	RX is displayed during reception (squelch opened)
TX	Transmission	Transmitter operates normally
Te	Transmitter was turned off automatically after 2 min continuous operation	
119.700	Active frequency	
ZELL SEE	Active frequency station identifier	Displayed when frequency and identifier are stored in the favorite list
VOL	Receiver volume level (default after a certain time delay)	When AUD is pressed the corresponding Audio Menu item and setting is displayed
DUAL	Active frequency AND Standby Frequency are monitored simultaneously	DUAL function is deactivated by frequency change or by pressing the DUAL button again
[03] MEM	Favorite list index (0-99)	When frequency and identifier are stored at this index ex:[03] they are displayed
119.700 upper	Active frequency	Displayed in large fonts.
125.800 lower	Standby/DUAL - frequency	Displayed in large fonts.
<	The pointer indicates what the turning knob will change VOL SQ VOX.....etc. Standby frequency	Arrow is positioned according to the button pressed (AUD or FREQ)

	User & Installation manual VHF- Communication Transceiver	Doc.-Nr.: DE-3000-800100e
	KRT2, KRT2M, KRT2RC	Revision 13.0 Jul. 2016



Indication	Meaning	Remarks
BAT	Supply voltage is low <10,5V	Low or defective battery / generator.
A-match	Antenna error	Bad antenna match
a v e	Status of certain Audio menu functions	a = AUX. Input active v = VOX active e = external Intercom switch active
MUC IN	Standby frequency station identifier	Displayed when frequency and identifier are stored in the favorite list

Figure 5: KRT2 Display

3.3 Menu levels

Displayed	Signification	Remarks
VOL	Volume	Default
SQ	Squelch	
VOX	Voice operated	Voice operated intercom
DIM	Display brightness	
BAT	DC source check	
INT	Intercom - Volume	
EXT	Volume of external devices	
TX**	PTT button selection	Left/Right/Both
SIT	Side tone	During transmitter operation
MIC	Setup-Menu for Microphones	Service-Menu without radio operation.



Figure 6: KRT2 Menu Levels

	User & Installation manual VHF- Communication Transceiver	Doc.-Nr.: DE-3000-800100e
	KRT2, KRT2M, KRT2RC	Revision 13.0 Jul. 2016

3.4 Self-test error reports

Display	Meaning	Remark
Er_PLL	Internal error, no transmission	Return the transceiver for maintenance
Er_ADC	Internal error, operation limited	Return the transceiver for maintenance
Er_FPA	Internal error; unit not usable	Return the transceiver for maintenance
Er_I2C	Internal error; unit not usable	Return the transceiver for maintenance
Er_D10	Internal error; reception corrupt	Return the transceiver for maintenance
Error_3V3	Internal error; unit not usable	Return the transceiver for maintenance
Key_Block	Internal error; unit not usable	Return the transceiver for maintenance

Figure 7: KRT2 Built In Tests (BIT)

	User & Installation manual VHF- Communication Transceiver	Doc.-Nr.: DE-3000-800100e
	KRT2, KRT2M, KRT2RC	Revision 13.0 Jul. 2016

4 OPERATION

4.1 General

In the normal operating mode in which the turning knob always is connected to the volume (VOL). The normal operating mode can be left by pressing the AUD, FREQ or MEMORY button.

When not in the normal mode and there is no pilot action for more than 10 seconds the unit returns to the normal mode.

4.2 ON / OFF Switching

ON / OFF switching is done by pushing the self-locking switch.

After power up the following display will be displayed:





Device-name
KRT2

Software-
Version e.g. V8.2

(Example)

The unit then starts in the normal operating mode using and displaying the data last used.

	User & Installation manual VHF- Communication Transceiver	Doc.-Nr.: DE-3000-800100e
	KRT2, KRT2M, KRT2RC	Revision 13.0 Jul. 2016

4.3 Frequency Selection

There are two different frequency selection methods:

- Direct Input
- Selection from the favorite list (index 0-99)

4.3.1 Direct Frequency Selection



The Standby-Frequency is set with the turning knob in 3 different ranges. The selected range is highlighted and can be changed with the FREQ button.

Frequency ranges are:

1xx.nnn

1nn.xnn

1nn.nxx

Press the FREQ button once or several times until the desired frequency range is highlighted. The unselected digits are displayed as dotted digits.

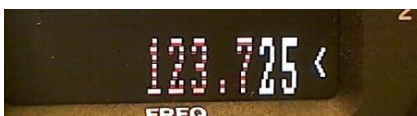



When the pointer is not next to the Standby Frequency window, it will be repositioned with the first pressing of the FREQ button.



Exchanges the Active and Standby frequencies.

When the Exchange button is not pressed, the Standby frequency display will return to its normal appearance after 20 seconds.

	User & Installation manual VHF- Communication Transceiver	Doc.-Nr.: DE-3000-800100e
	KRT2, KRT2M, KRT2RC	Revision 13.0 Jul. 2016

4.3.2 Frequency Selection from the Favorites List

By pressing  and operating the turning knob a specific favorite list position can be accessed [xx] (xx = index 0 ... 99). When frequency and station identifier have been defined, they will be displayed in the Standby and station identifier windows.

The favorite identifiers list can be sorted in alphabetic order (see 4.3.3 Storing and Editing Favorites).

To exit this menu, press the  key.



The selection procedure can be terminated with either the AUD or FREQ buttons. Without pressing any of these buttons the unit will return to its normal operating mode after about 15 seconds.

4.3.3 Storing and Editing Favorites

Any displayed Standby Frequency can be associated with an identifier and both can be stored as favorites in the favorite list. The frequency and identifier of a favorite can be edited.

First press the  button and go to the desired favorite list position to be edited using the turning knob (index [00 ...99]).

Press the MEMORY button a second time and „-EDIT-“, will show up in the program window.

	User & Installation manual VHF- Communication Transceiver	Doc.-Nr.: DE-3000-800100e
	KRT2, KRT2M, KRT2RC	Revision 13.0 Jul. 2016



In the identifier window a blinking cursor will show up under the extreme left character.

The turning knob selects the desired character.

The AUD button positions the cursor one character to the right. The DUAL button positions the cursor one character to the left and simultaneously erases this character.

The station identifier can consist of a maximum of 8 characters.

To change frequency just press the **FREQ** button and follow the normal direct input procedure to edit the frequency, see “4.3.1 Direct Frequency Selection”.

To quite the frequency input press the **MEMORY** button again in order to go to the station identifier window for editing the identifier if required.

Using the buttons **FREQ** and **MEMORY** it is possible at any time to toggle between identifier and frequency inputs.



Keep in mind the watch dog timer which will terminate the input mode after 20 sec.

Termination and Save

To save the entered identifier, press the  key as the cursor is on the station name, “SAVE” will appear and the system will go back to the favorite selection.

A **sorting process** can be activated by pressing the “MEM” button again from the EDIT-mode.

“SORT?” will be displayed for 20 seconds and it should be activated with  or skipped with “MEM”.

	User & Installation manual VHF- Communication Transceiver	Doc.-Nr.: DE-3000-800100e
	KRT2, KRT2M, KRT2RC	Revision 13.0 Jul. 2016

When activated all 99 favorites will be sorted in alphabetical order and the process can take several minutes.

During the sorting procedure “RUN nn“ is displayed in the program window, with nn being the running index.

After a 6 seconds time out or by ending the sort, the transceiver resumes its normal operating mode.

When the “MEM” button is pressed at the time “RUN nn“ is displayed, the sorting procedure is terminated. The favorite list is then partially sorted and the transceiver resumes its normal operating mode.

Example:

1.) Button MEM -> SEL [23] = Select location

2.) Button MEM -> -EDIT- = Input of name

Rotation knob to select the characters

For cursor use (AUD) (DUAL)



Frequency setting -> press rotating button

Use button MEM to go back to -EDIT-

3.) Button  -> shortly SAVE -> back to 1.) (do nothing = cancelling)

4.) Button MEM -> question for “SORT?” Yes = , No = MEM or do nothing.

If the function is abandoned before completion, it will be exited after a 6 seconds time out with no activity. The data will not be saved.

	User & Installation manual VHF- Communication Transceiver	Doc.-Nr.: DE-3000-800100e
	KRT2, KRT2M, KRT2RC	Revision 13.0 Jul. 2016

4.4 AUD – Audio Menu



Any action in the Audio Menu requires the pointer (<) to be next to the Audio menu window (see picture). When the pointer is next to the Standby frequency window, the pointer can be repositioned by pressing the AUD button once.

VOLnn is the Audio menu default display. No action on any control for more than 10 seconds will result in the VOLnn being displayed.

Audio Menu items can be accessed in the following order by repeatedly pressing the AUD button.

VOL (default), SQ, VOX, TXm**, INT, EXT, DIM, BATtst, SIT, MIC

Audio menu items to right of the above list are less used than the left ones.

4.4.1 VOL – Volume

Turning the turning knob changes the receiver volume.

VOLnn Range: 01 – 20





The VOL setting only concerns the receiver and not the intercom system. Intercom volume values are set in the INT audio menu.

4.4.2 SQ – Squelch

Pressing the AUD button once enables the turning knob to change the squelch level values.

SQnn Value range: 01 – 10

The Squelch setting is depending on several factors.

	User & Installation manual VHF- Communication Transceiver	Doc.-Nr.: DE-3000-800100e
	KRT2, KRT2M, KRT2RC	Revision 13.0 Jul. 2016

For engine driven airplanes an initial setting of 3-5 is recommended. For gliders a setting of 2 is recommended. The lower the Squelch level value the higher is the input sensitivity. A high sensitivity setting is susceptible to noise from other sources like ignition strobe-lights etc.

	Standard SQ-level is 3...5. Higher setting will suppress weaker input signals. 01 = Squelch off, 02 = for long range. Squelch does not influence the intercom system.
---	---

4.4.3 VOX – Intercom Voice Trigger Level Setting

Pressing the AUD button twice enables the turning knob to change the voice level which triggers the intercom.

The intercom voice trigger level must be set to a value which prevents normal cockpit noise from being heard in the earphones. The intercom system should only be activated when talking at a normal voice level into the microphone.

The higher the trigger level the louder the voice must be in order to trigger the intercom system.

VOX on condition is indicated by flag “v”.

VOXnn Range: 01 – 10



	The larger the value, the louder one must speak in order to activate the Intercom connection. VOX on condition is indicated by flag “v”. For installation with loudspeakers set VOX to 10 to switch it off.
---	---

4.4.4 Manual Intercom

With cockpit loud background noise or with uncompensated microphones the Intercom can be controlled manually by using an external switch.

Therefore the VOX system must be activated permanently by selecting VOX: 01.

To turn off the Intercom the talk switch (default closed) must be opened, which will be indicated by “e”.

	User & Installation manual VHF- Communication Transceiver	Doc.-Nr.: DE-3000-800100e
	KRT2, KRT2M, KRT2RC	Revision 13.0 Jul. 2016

Deactivation of the intercom is done with an opened external microphone button (Ground connection to pin 12), this is indicated with an “e” on the display.

This mode only works with a deactivated external audio input (see “4.4.7 EXT – External Audio Input Volume”).

In gliders the VOX has to be set to 10 in order to disable the speaker control.

4.4.5 TXm – PTT Switch Selection

Pressing the AUD button three times enables the turning knob to enable certain PTT switches.

On transmission the microphone which is related to the PTT-L/R will be enabled. The equivalent indication is TX or TX1 / TX2.

On transmission the PTT-L/R related microphone will be the only one activated.

TXm** *- Left / -* Right / ** Both

4.4.6 INT – Intercom Volume

Pressing the AUD button four times enables the turning knob to set the intercom volume.



INTnn Range: 1 – 9

4.4.7 EXT – External Audio Input Volume

Pressing the AUD button five times enables the turning knob to set the external audio input volume. External audio inputs can be audio alarms, voice alarms, Vario, etc. The required level is 200mVpp (6Vpp max). Activation occurs for settings >00 and will be indicated by the flag “a”.

- 00 = turning off,
- 01 = lowest gain without threshold
- 09 = highest gain with interference suppression threshold.

EXTnn Range: 0 - 9

	User & Installation manual VHF- Communication Transceiver	Doc.-Nr.: DE-3000-800100e
	KRT2, KRT2M, KRT2RC	Revision 13.0 Jul. 2016

4.4.8 DIM – Display Brightness

Pressing the AUD button six times enables the turning knob to set the display brightness.

DIMnn Range: 01 – 16

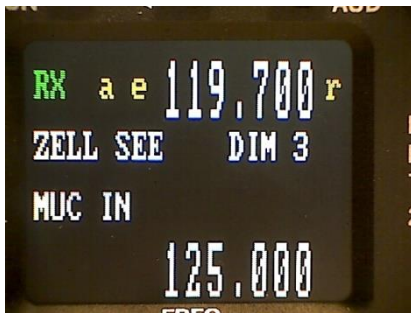



The display consumption at 12V is 70mA max and 10mA min. In addition the battery voltage in Volts is indicated.

4.4.9 BAT – Battery Test

Pressing the AUD button seven times enables the turning knob to display the battery voltage.



	User & Installation manual VHF- Communication Transceiver	Doc.-Nr.: DE-3000-800100e
	KRT2, KRT2M, KRT2RC	Revision 13.0 Jul. 2016

4.4.10 SIT – Side tone

Pressing the AUD button eight times enables the turning knob to set the side tone volume (for gliders should be set to 01).

SITnn Range: 1 – 9

4.4.11 MIC – Setup

This mode is for microphone setup and test only without using the PTT. It is a service mode and it is not designed for normal operation.

Each of the two microphone input channels can be configured individually, which enables different microphone types to be used.



A maximum of two microphones of same type may be connected to each microphone input channel (see chapter 6.6.1 Microphone-Connection).

The MIC – Setup is the last item of the Audio menu and can be accessed by pressing the AUD button nine times.



By pressing the DUAL button repeatedly L, R and AUTO can be selected (Left “L” in the example).

- L : Left = Left microphone.
- R : Right = Right microphone.
- AUTO : Auto mode.

	User & Installation manual VHF- Communication Transceiver	Doc.-Nr.: DE-3000-800100e
	KRT2, KRT2M, KRT2RC	Revision 13.0 Jul. 2016

Menus L and R:

By means of the turning knob the displayed microphone input channel amplifier gain (MIC-level 01 = low gain, 09 =high gain) can be selected individually. The microphone signal level is dynamically displayed with a bar and a numeric value from 0.0 to 1.0).

The initial MIC-level should be 5; the engine should be running, use a headset or earphone and speak at a normal voice level to fine-tune the MIC-level. Whenever a new MIC level is selected, the dynamic bar indicator should then be at about 50%.

Special hint: During MIC-Setup activation, the speaker state will be taken into account (SQU on/off), if the state is active an acoustic feet-back may be heard.

The range of the MIC-level for standard microphones is 1 to 9.

MIC levels 10 and 11 are special settings for low microphone levels like dynamic micro-phones often used in gliders.



Level 10 is used for non-amplified Electret microphones with an 8 volt supply voltage.

Level 11 is for dynamic microphones only.

For high gain selection (> 9) the use of side tone can lead to a feed-back at transmission. In that case the side tone should be set to SIT=01.

The new values will be stored upon exiting the microphone setup menu.

AUTO must be selected in order to activate the AUTO menu, else use L or R to activate the Left and & Right microphone menu.

	User & Installation manual VHF- Communication Transceiver	Doc.-Nr.: DE-3000-800100e
	KRT2, KRT2M, KRT2RC	Revision 13.0 Jul. 2016

Menu Auto

In the AUTO mode (up to software version 6.16 every 30 sec. then at transmission start) the left microphone impedance is measured. When a dynamic microphone is recognized, the left channel is switch to 11, the right channel is unaffected. When returning to the standard configuration, the original L and R values are restored.



	A simultaneous operation on Electret and Dynamic microphones is not possible (there is just one DC source for both ports). For dynamic mode this source must be turned off automatically.
---	---

The display of microphone type (lower right side) is done upon activation of the microphone menu.

When an Electret microphone is recognized, the values used are the one that were saved upon leaving the menu.



The MIC submenu is terminated by pressing the AUD button.

	User & Installation manual VHF- Communication Transceiver	Doc.-Nr.: DE-3000-800100e
	KRT2, KRT2M, KRT2RC	Revision 13.0 Jul. 2016

Additional indications

Additional indications for test purposes:

- RxS : RF receiver input level (from Automatic Gain Control)
- Ext : External audio input voltage
- Mic : dyn (dynamic) or std (standard)

The microphone type is displayed when the microphone menu is entered.

This Symbol  appears on right side of STBY Frequency in AUTO-mode if the dynamic microphone has been recognized and activated after transmission. In that case the intercom voice triggering level VOX is set to 10 (switched off).

To reactivate the intercom after a microphone change, a short press of the PTT is required.

4.4.12 Menu lock

For school operation the menus area TXm to MIC-setup can be locked.



To lock or unlock the button combination AUD & FREQ has to be pressed simultaneously for > 2 seconds.

In lock condition there will be displayed an “L” at the right end of the third line.

To store those condition the setting of SQnn should be changed before turning off.

VOL	SQ	VOX	<i>TXm</i>	<i>INT</i>	<i>EXT</i>	<i>DIM</i>	<i>CON</i>	<i>SIT</i>	<i>MIC</i>
Available			<i>Locked and not available</i>						

Figure 8: KRT2 Menu Lock

	User & Installation manual VHF- Communication Transceiver	Doc.-Nr.: DE-3000-800100e
	KRT2, KRT2M, KRT2RC	Revision 13.0 Jul. 2016

4.5 DUAL Watch

Because the communication transceiver KRT2 contains only one receiver, DUAL watch is achieved by alternating between the Active and Standby frequencies.

The DUAL button activates and deactivates the dual watch function. Deactivation also can take place by pressing either the **FREQ** or **MEMORY** buttons.

The frequencies to be watched should be selected prior to the DUAL watch selection.

The frequencies to be used must be selected before using dual watch and the squelch level **SQ** must be set to 2 or more in order to eliminate noise. Scanning Frequencies is only possible when differentiating between radio noise and radio transmissions.

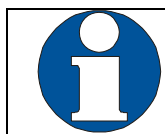

There must be radio noise suppression in order to recognize reception. The squelch level **SQ** must be set to 2 or higher.

When DUAL watch is activated, “DUAL“ is displayed on the lowest line. The pointer next to the DUAL display indicates the frequency on which there is reception.

The Active frequency always has priority and the receiver remains on the active frequency as long as there is reception on this frequency.

When there is no reception on both the Active frequency and the Standby frequency the receiver scans both frequencies 5 times per second.

When reception is detected on the Active frequency the reception on the standby frequency is interrupted until the end of the reception.

When a reception is detected on the Standby frequency the receiver stays on the Standby frequency, however it switches to the Active frequency every 2 seconds for a duration of 0.3 seconds. If a signal is detected on the active frequency the reception will be switch to that frequency.

AIRplus	User & Installation manual VHF- Communication Transceiver	Doc.-Nr.: DE-3000-800100e
	KRT2, KRT2M, KRT2RC	Revision 13.0 Jul. 2016

The pointer next to the DUAL display indicates on which frequency there is reception.



Active-frequency-reception





Standby-frequency-reception

Figure 9: KRT2 Active & Standby frequencies

Standby and Active frequencies can be exchanged when in the DUAL mode. The transmitter operates on the Active frequency only.

Summary:

- Select the Standby frequency to be monitored in addition to the active frequency.
- With the AUD button and turning knob set SQnn to 2 or higher.
- With the DUAL button activate the DUAL watch function.
- When there is no reception on both the Active frequency and the Standby frequency the receiver scans both frequencies 5 times per second.
- When scanning the Active frequency always has priority.
- Deactivate the DUAL watch function with the DUAL or FREQ or MEMORY buttons.

	User & Installation manual VHF- Communication Transceiver	Doc.-Nr.: DE-3000-800100e
	KRT2, KRT2M, KRT2RC	Revision 13.0 Jul. 2016

4.6 Transmitter Operation

The unit transmits on the active frequency (upper line) as long as a PTT (press to talk) switch is pressed.



Transmission



Reception

Figure 10: KRT2 TX & RX operations

“TX” indicates normal transmitter operation.

“RX” indicates a receiver operation.



In the lower left corner of the display the carrier modulation is dynamically displayed. It corresponds to the side tone which is not available on gliders when no earphones are in use.

In order to avoid the blocking off of the frequency by unintentional long transmissions (stuck microphone) the transmitter is switched off after two minutes and the display changes from „TX“ to „Te“. To resume transmission the PPT switch first must be released and then be pressed again.

While transmitting the external audio input will be turned off automatically and the microphone input, selected during the pre-setting in the TXm-menu, will be selected.

The differential speaker output will be turned off to prevent an audio feedback to the microphone. For the same reason; the speaker is turned off when the intercom (VOX) is active.

The output for the headset will carry the side tone.

	User & Installation manual VHF- Communication Transceiver	Doc.-Nr.: DE-3000-800100e
	KRT2, KRT2M, KRT2RC	Revision 13.0 Jul. 2016

4.6.1 Two PTT Configuration

There are two different PTT assigned for each of the left and right side microphones. This enables the deactivation of the unused one preventing additional noise and unintentional talking on transmission.

In case there is just one PTT and multiple headsets in use both the PTT-L and PTT-R must be tied together, see chapter “4.4.5 TXm – PTT Switch Selection”.

4.6.2 Self-Test monitor

Software diagnostics operate continuously in the background in order to test the system.

The field for battery status & error (see Control Elements Overview) is used to display warnings and in case of hardware failure, different error reports will be displayed here.

The warnings are:

BAT Low battery voltage (becomes active < 10,5V)



At transmission

A-match Bad antenna match or defective antenna.

Also while transmitting the TX-flag (left top) will change to:

Te If transmission time has exceeded (> 2 minutes)

All other reports starting with Er_.... Indicating a major hardware failure and consequently the radio has to be returned to the factory.

	User & Installation manual VHF- Communication Transceiver	Doc.-Nr.: DE-3000-800100e
	KRT2, KRT2M, KRT2RC	Revision 13.0 Jul. 2016



4.6.3 Optical side tone

Especially when used in gliders, where headsets are generally not worn and thus no side tone is heard, it is very helpful to see if the microphone is operating properly.

At left lower side, there is a modulation indicator that depicts the voice level. When there is no modulation it becomes a small dot approximately in the centre.

Also if it lays far off centre, it indicates that there is bad antenna matching.



	User & Installation manual VHF- Communication Transceiver	Doc.-Nr.: DE-3000-800100e
	KRT2, KRT2M, KRT2RC	Revision 13.0 Jul. 2016

4.7 Resetting to factory settings

Returning to the factory settings can only be initiated during power-up.

To do this, during power-up the MEM and DUAL buttons must be pressed simultaneously and the display will show "SET DEFAULTS". When the buttons are released the resetting to the factory settings takes place. When resetting is completed "DONE" is displayed.

4.8 SET UP - Menu

During power-up the MEM button must be pressed.

The message "protect mode" is displayed, just wait until it changes.



There are two functions available within the Set-up menu:

- ERASE – Erasing of the favorites (frequency and identifier)
- Channel Spacing – 25kHz / 8,33kHz

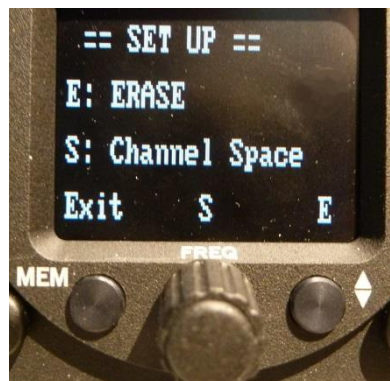
Programming of the Set-up is done with the lower 3 buttons next to the symbols (Exit, S, E). Their function is described on the display.





To exit the SET-UP menu, use the MEM button. The unit remains powered and the normal operating mode is resumed.

	User & Installation manual VHF- Communication Transceiver	Doc.-Nr.: DE-3000-800100e
	KRT2, KRT2M, KRT2RC	Revision 13.0 Jul. 2016

4.8.1 ERASE – Erasing the Favorites List

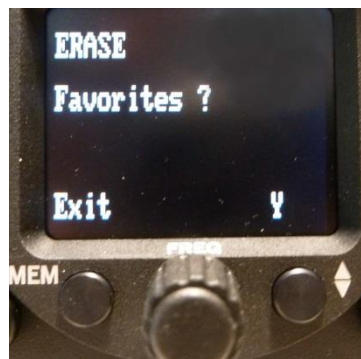
When in the SET UP – Menu select the “ERASE” sub-menu with the buttons next to the symbols (Exit, Y).



Erasing the favorites (frequency and identifier) starts after the  button has been pressed again. This procedure may last a few minutes during which time the message “ERASING” is displayed.



All INFO frequencies and identifiers that were stored on delivery are lost and all favorite index positions (01 to 99) are available to the user.

4.8.2 Channel Spacing

When in the SET UP – Menu pressing the FREQ (S) button will change the KRT2 into the Channel Space submenu.



The desired channel spacing then can be selected and the (X) then indicates the actual channel spacing.

	User & Installation manual VHF- Communication Transceiver	Doc.-Nr.: DE-3000-800100e
	KRT2, KRT2M, KRT2RC	Revision 13.0 Jul. 2016

5 Remote Control

Tandem-seat airplanes can be equipped with the KRT2RC Remote Control Unit. The remote control unit is connected to RS232 serial interface and enables selection of the most common settings like frequency, volume, squelch, VOX, display contrast and brightness. In addition the unit has an independent memory for the favorites (frequency and identifier).

Transmission error messages are displayed in the error window in the third line:



- R_Time = Time-out transmission error
- R_ChkS = Checksum error
- R_Cmd = Unknown command
- R_Char = Data error
- R_Freq = Wrong Frequency

The error message disappears when a valid command or a new frequency has been input, or after 5 seconds.

Remote control unit errors do not interfere with the KRT2 transceiver operation.

Data transmission between the transceiver KRT2 and the remote control unit (KRT2-RC) is checked once a minute. An “r” in the upper right corner is displayed when there is no malfunction.

The KRT2-RC can also operate the KRT2 in a fully stand-alone mode such and allow the KRT2 to be installed anywhere in the aircraft, and be operated remotely by the KRT2C. This feature will be useful in tandem aircraft, or aircrafts with very little space behind the instrument panel.

	User & Installation manual VHF- Communication Transceiver	Doc.-Nr.: DE-3000-800100e
	KRT2, KRT2M, KRT2RC	Revision 13.0 Jul. 2016

6 Installation



6.1 Installation Hints

The following hints should be considered for installation.

A certified maintenance shop should perform the installation and wiring (or as required by local national regulations). For the wiring diagram refer to chapter “6.8 Wiring”.

The KRT2 is designed as a single block unit for the installation in cockpit environment of general aviation aircrafts under consideration of the following limitations:

- Installations are to be made in accordance with appropriate EASA or FAA approved guidelines.
- The equipment must be connected to a VHF antenna in order to satisfy FAA TSO-C169a.
- The conditions and tests for ETSO/TSO approval of this article are minimum performance standards. Those installing this article, on or in a specific type or class of aircraft, must determine that the aircraft installation conditions are within the ETSO/TSO standards. ETSO/TSO articles must have separate approval for installation in an aircraft. The article may be installed only according to 14 CFR part 43 or the applicable airworthiness requirements.
- The development assurance level for the software (refer chapter “2.3 Quantitative Safety Objective Identification”) is appropriate for the type of aircraft. By this, the installation is limited to Part 23 Class 1 and Class 2 airplanes per AC23.1309-1D.
- The environmental conditions at the place, where the equipment is installed, are inside the limits of the performed environmental qualification (refer chapter “8.2 Technical Data”).
- The equipment classes (refer chapter “8.2 Technical Data”) are appropriate for the type of aircraft.
- The equipment is not intended to be installed in areas where fluid contamination could be commonly encountered.

	User & Installation manual VHF- Communication Transceiver	Doc.-Nr.: DE-3000-800100e
	KRT2, KRT2M, KRT2RC	Revision 13.0 Jul. 2016

6.2 Telecommunication Data

The following data may be required for the radio station licence application.



Manufacturer	AIRplus Maintenance GmbH
Type	KRT2
EASA Number	EASA.21O.10058303
Part Number	P/N 100-(0XXX)-(XXX) KRT2 P/N 110-(XXXX)-(XXX) KRT2RC P/N 100-(1XXX)-(XXX) KRT2MH P/N 100-(2XXX)-(XXX) KRT2MV
Power Output	6 W
Frequency:	118,000 – 136,975 MHz
Emission Identifier:	6k00A3E for 25khz channel spacing 5k00A3E for 8,33kHz channel spacing

Figure 11: Telecommunication data

6.3 Scope of delivery

Part Number	Description
KRT2	KRT2 - VHF Transceiver
ZUB2 (4 pcs)	Mounting screw KRT2 - for panels up to 3mm
DE-3000-800100	Operation and Installation Manual
	EASA Form 1

Figure 12: Small parts

	User & Installation manual VHF- Communication Transceiver	Doc.-Nr.: DE-3000-800100e
	KRT2, KRT2M, KRT2RC	Revision 13.0 Jul. 2016



6.4 Unpacking and Inspecting the Equipment

Carefully unpack the equipment. Damages due to transportation must immediately be reported to the shipping company. Save the shipping container and all packing material to substantiate your claim.

	For storage or reshipment the original packing material should be used.
---	---

6.5 Mounting

- In cooperation with the maintenance shop, mounting details are specified. The maintenance shop can manufacture and install all cables that may be required.
- Avoid installing the unit in the vicinity of heat sources. Sufficient air-circulation is required.
- There must be sufficient space for cables and connectors.
- Avoid sharp bends and wiring close to control cables.
- Cable length must be such that connectors are accessible for repair.
- The wiring to the transceiver must be installed such that water droplets formed by condensation will not run into the connector.
- Remove the turning knob in order to install the transceiver:
 - Remove the turning knob cap with an appropriate tool.
 - Loosen the screw and remove the turning knob.
 - Install cap correctly oriented!
- Installation is from the front side of the instrument panel with four 4mm screws in a panel cut-out as indicated in “6.8.4 Wiring Diagram”.
- For installation details and drawings refer to chapter “6.8.4Wiring Diagram”.

	User & Installation manual VHF- Communication Transceiver	Doc.-Nr.: DE-3000-800100e
	KRT2, KRT2M, KRT2RC	Revision 13.0 Jul. 2016

6.6 Electrical Connections

The 15-pin D-Sub connector contains all electrical connections except the antenna.



The battery plus connection must be protected with at least 3-amps slow blow fuse!

6.6.1 Microphone-Connection

Both the L (left) and R (right) microphone input channels can either be connected to standard microphones (standard signal level 1Vpp) or to dynamic microphones (standard signal level 5mV to 10mV). Input R has less sensitivity (30mV).



For standard microphones a supply voltage of 8V at 330Ω is provided. Elementary Electret microphones can also be connected. They have considerably lower signal levels and therefore require an 8V supply voltage.

The microphone input channel amplifier gain can be selected via the MIC-Setup menu “4.4.11 MIC – Setup”.

When dynamic microphones are used in gliders the 8V supply voltage is switched off for power saving purposes.

Standard microphones normally used as in headsets, together with dynamic microphones generally cannot be used at the same time, but instead alternatively. If input R is not used it should be loaded or grounded and not be left unconnected.

Motor gliders should have a toggle switch installed to differentiate between motor less flight with dynamic microphones and powered flight with headsets.

	User & Installation manual VHF- Communication Transceiver	Doc.-Nr.: DE-3000-800100e
	KRT2, KRT2M, KRT2RC	Revision 13.0 Jul. 2016

When the AUTO mode is selected in the MIC-Setup menu the KRT2 automatically recognizes on MIC-L (pin 3) which microphone type has been switched and acts accordingly.

Both inputs (L and R) must not be wired together. L is the master input.

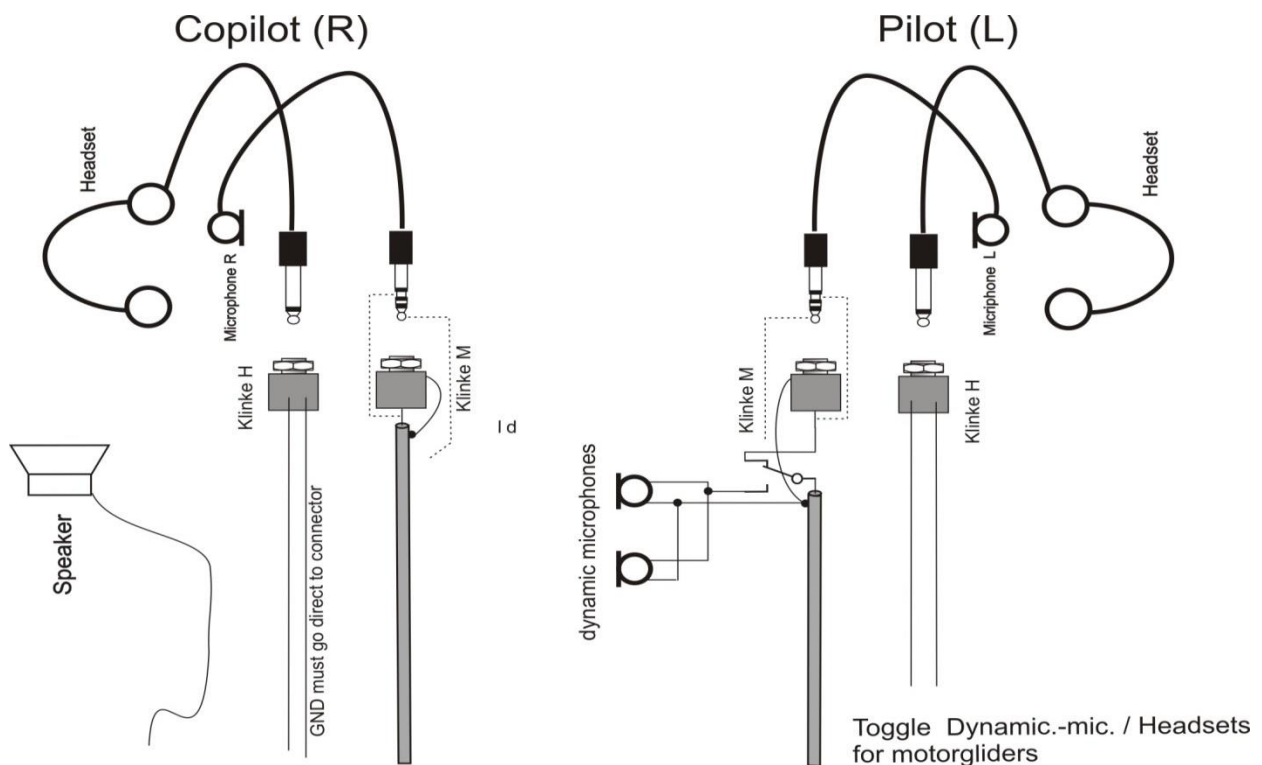



Figure 13: Head sets

Because the 8V supply voltage is switched off when dynamic microphones are used during glider flight the second (co-pilot) headset microphone is disabled.

A maximum of two microphones of same type may be connected to each microphone input channel. Standard microphones have a large difference in power consumption; therefore different models must not be mounted in parallel.

	User & Installation manual VHF- Communication Transceiver	Doc.-Nr.: DE-3000-800100e
	KRT2, KRT2M, KRT2RC	Revision 13.0 Jul. 2016

6.6.2 Speaker & open microphone:

An installation with open microphone together with a speaker and intercom is not possible.

Running a speaker together with an open microphone (goose neck) the Intercom operation has to be turned off by setting VOX=10 or opening the intercom switch (indicating “e”) otherwise a feedback from the speaker will occur.

6.6.3 Earphone Connection

Several earphones of same type can be connected in parallel. The total impedance should not be less than 60 Ohms.

6.6.4 External Audio Input



Audio alarms can be made available via the external audio input. When this input is not used it must be connected to ground in order to avoid noise. PIN5 must be connected to ground (GND).

6.6.5 Speaker Connection

The high output power for the speaker requires a differential interconnection.

This does not allow for one side of the speaker wires to be grounded. Both the wires have to be installed fully insulated.

Special intention has to be paid off at gliders after retrofitting on older installations. Check with a meter the resistance between one of the speaker wire and the case of KRT-2, it should be at high impedance.

	User & Installation manual VHF- Communication Transceiver	Doc.-Nr.: DE-3000-800100e
	KRT2, KRT2M, KRT2RC	Revision 13.0 Jul. 2016

After turn on it will appear this warning on the screen in case the speaker is grounded.



Running under that condition may cause a defect.

6.7 Final Audio-Setup

This is an overview for a correct audio set up depending on the usage. Ground the unused MIC.-R input if unused.

6.7.1 For glider flights



- Press button AUD 3x for VOX: Set to VOX 10 (turn off) or open the intercom switch (indicating “e”).
- Press button AUD 4x for TXm: Set to TXm**.
- Press button AUD 6x for EXT: Set to EXT 00 (turn off).

For dynamic Microphones:

- Press button AUD 10x for MIC: Set to MIC-L to Level 11.
- Press button AUD 8x for SITxx: Set to SIT01 (turn to min.).

For Electret Microphones:

- Press button AUD 10x for MIC: Set to MIC-L to a level (3 to 10) so that indication is just exceeding half the maximum value.
- Leave the menu in position “L” (not AUTO).

	User & Installation manual VHF- Communication Transceiver	Doc.-Nr.: DE-3000-800100e
	KRT2, KRT2M, KRT2RC	Revision 13.0 Jul. 2016



6.7.2 For motor gliders dual seaters

For change mode (motoring & headset – gliding & dynamic microphone)

- Press button AUD 3x for VOX:
 - Set to VOX 3. on condition for motoring.
- Press button AUD 4x for TXm:
 - Set to TXm**.
- Press button AUD 6x for EXT:
 - Set to EXT 00 (turn off), or on condition.
- Press button AUD 10x for MIC:
 - Set MIC-L to level 5 or as required,
 - Set MC-R as required or to 1 if unused.
 - Select AUTO and leave menu.

6.7.3 For Motor planes

- Press button AUD 3x for VOX:
 - Set to VOX 3 (turn off).
- Press button AUD 4x for TXm:
 - Set to TXm**, or on condition.
- Press button AUD 6x for EXT:
 - Set to EXT 00 (turn off), or on condition.
- Press button AUD 10x for MIC:
 - Set to MIC-Level 3 or as required
 - Set MC-R as required or to 1 if unused.
- Leave the menu in position “L” (not AUTO).

	User & Installation manual VHF- Communication Transceiver	Doc.-Nr.: DE-3000-800100e
	KRT2, KRT2M, KRT2RC	Revision 13.0 Jul. 2016

6.8 Wiring

6.8.1 Wire Gauges

Supply lines (Power, GND): AWG18 (0,83 mm²)
 Control lines: AWG22 (0,38 mm²)
 All wires must be aviation certified.

6.8.2 Connector Pin-Configuration

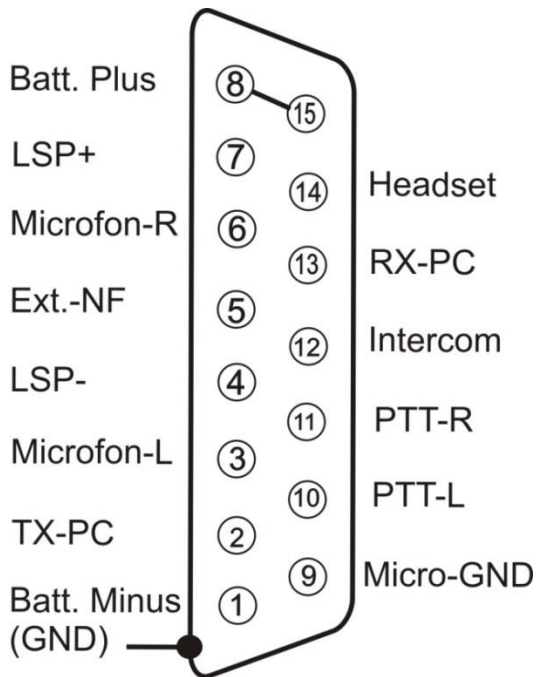





Figure 14: Connector pin out

	If manual intercom is not used, pin 12 should be grounded.
---	--

	User & Installation manual VHF- Communication Transceiver	Doc.-Nr.: DE-3000-800100e
	KRT2, KRT2M, KRT2RC	Revision 13.0 Jul. 2016

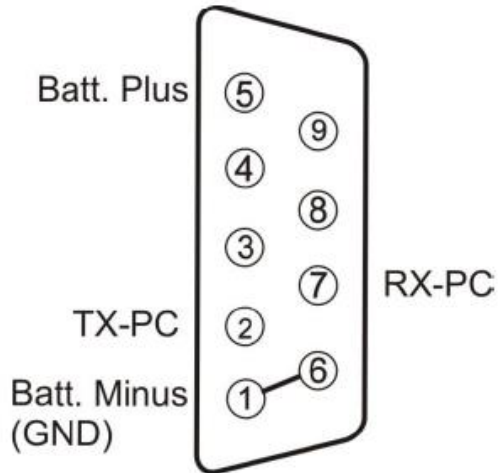



Figure 15: Remote control pin out

The nine pins connector on the KRT2RC is used for the connection to the KRT2.

6.8.3 General hint

The following drawings are not covering all possible configurations. There are too many different microphones with sometimes incompatible performances on the marked. Because of this we generally recommend to use Electret Microphones providing a standard output level.



AIRplus	User & Installation manual VHF- Communication Transceiver	Doc.-Nr.: DE-3000-800100e
	KRT2, KRT2M, KRT2RC	Revision 13.0 Jul. 2016

6.8.4 Wiring Diagram

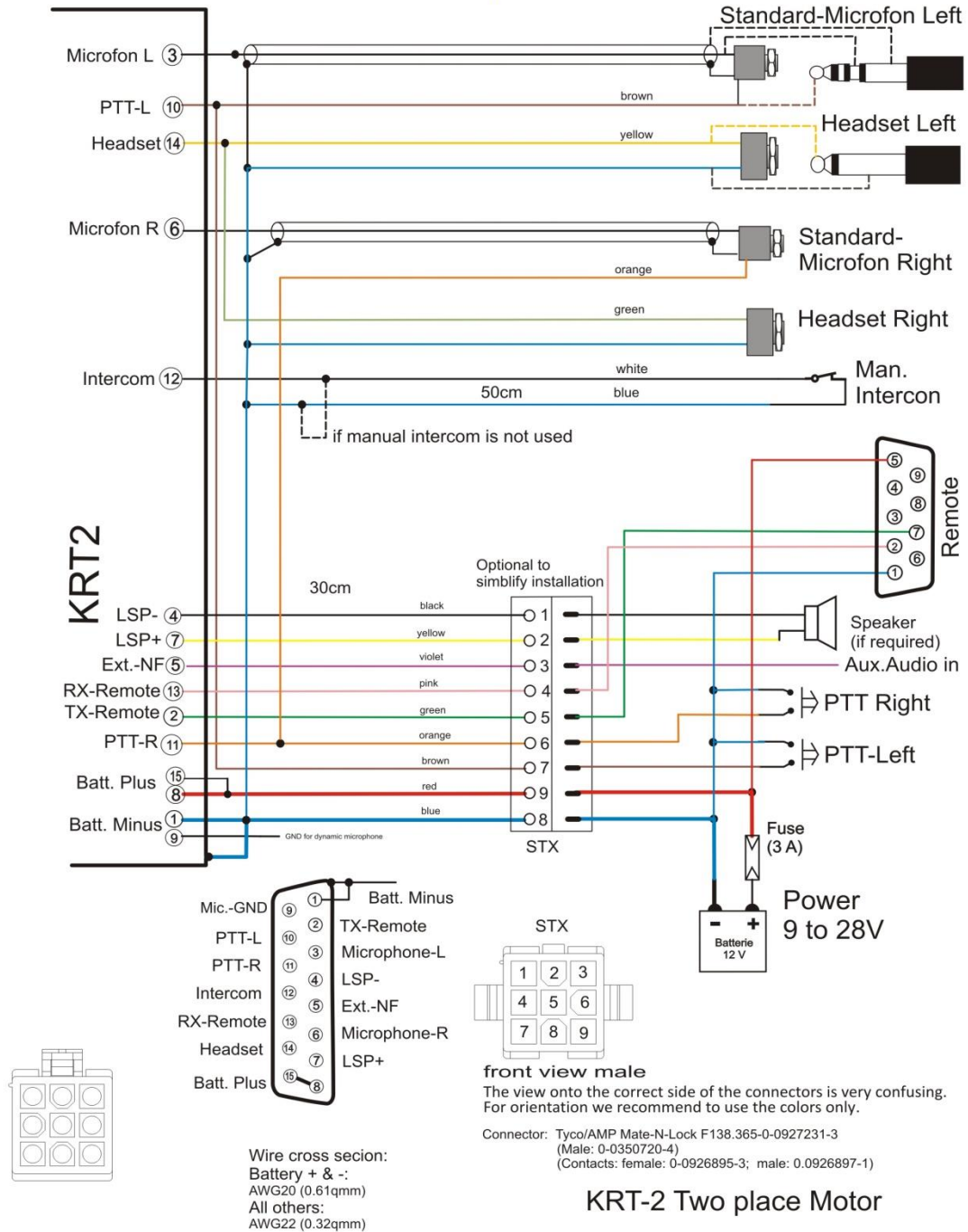
6.8.4.1 Two place motor aircraft connection



Microphone-Setup: set L / R as required for headset, do not leave in AUTO

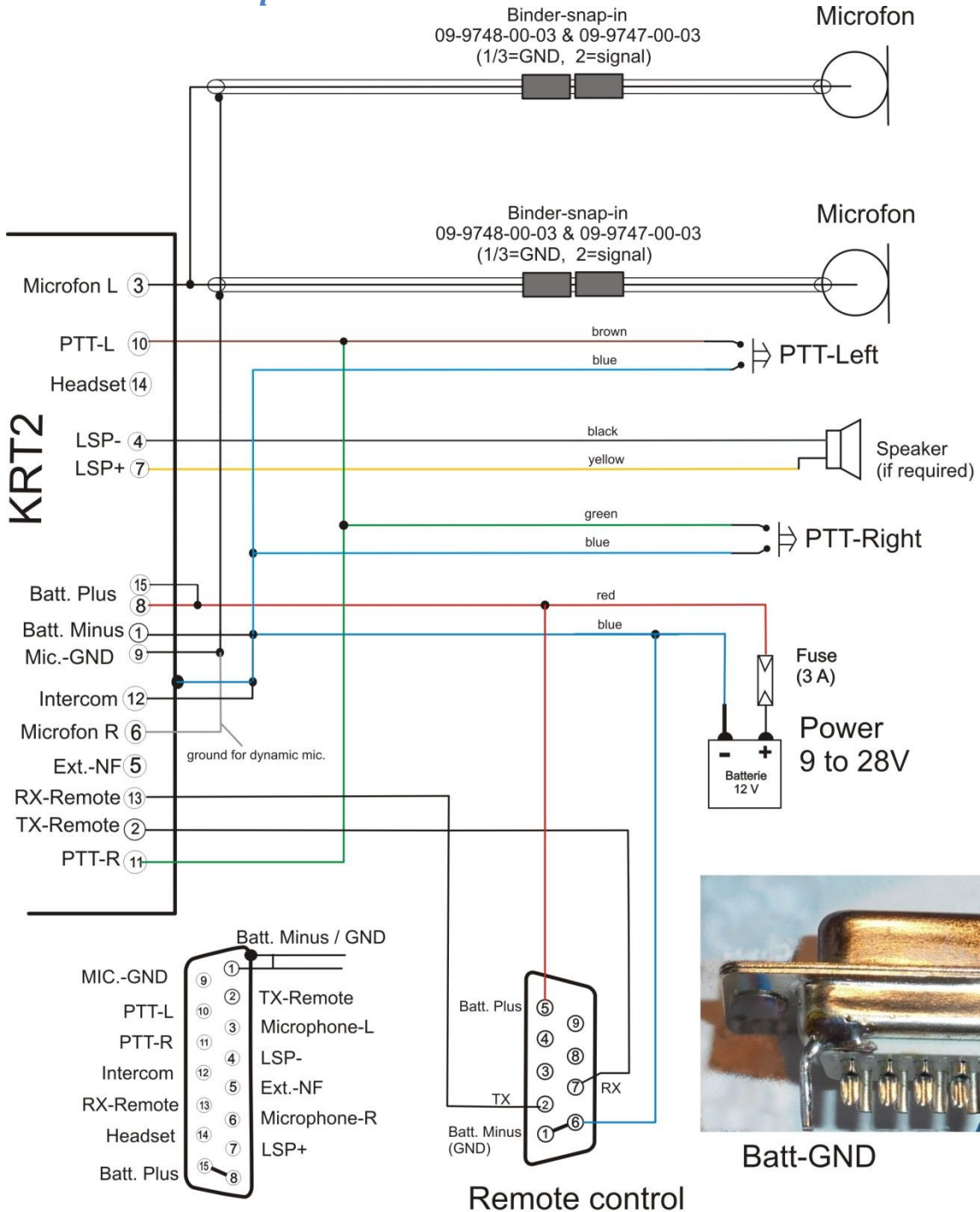

	User & Installation manual VHF- Communication Transceiver	Doc.-Nr.: DE-3000-800100e
	KRT2, KRT2M, KRT2RC	Revision 13.0 Jul. 2016

6.8.4.2 Glider two place connection



KRT-2 Glider-Dual
V3e

Microphone-Setup: leave in L =11, (not AUTO)

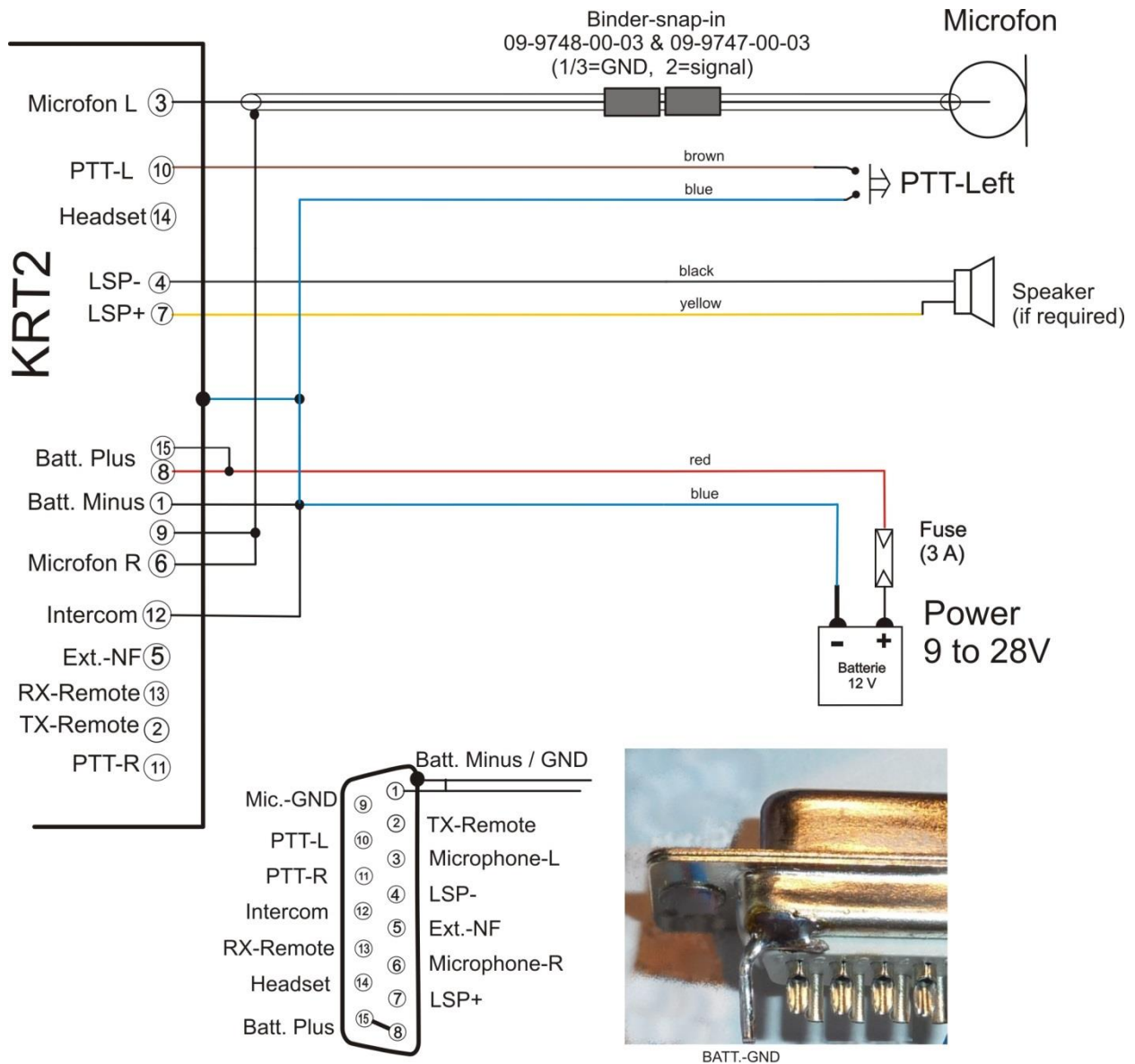

	User & Installation manual VHF- Communication Transceiver	Doc.-Nr.: DE-3000-800100e
	KRT2, KRT2M, KRT2RC	Revision 13.0 Jul. 2016

6.8.4.3 Glider single



KRT-2 Glider-Single
 V4c

Microphone-Setup: leave with L =11 for dynamic, (not AUTO)

	User & Installation manual VHF- Communication Transceiver	Doc.-Nr.: DE-3000-800100e
	KRT2, KRT2M, KRT2RC	Revision 13.0 Jul. 2016

6.8.4.4 Motor glider single

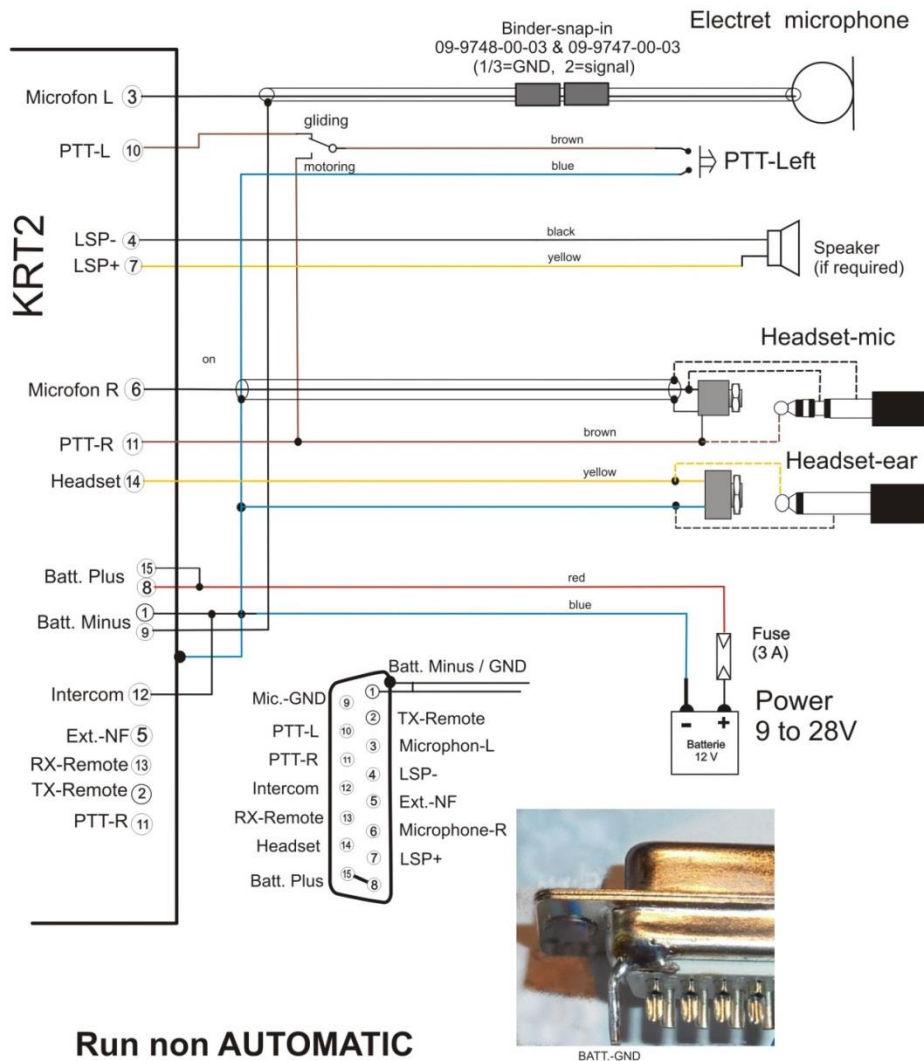



KRT-2 Motorglider-Single
PTT-Select.

Microphone-Setup:

For Electret set L / R as required for headset, do not leave in AUTO-mode.



For Dynamic, use a switch to cut off the dynamic mic. (If motoring) and leave setup in AUTO-mode, wire PTT-L and PTT-R in parallel.

	<p align="center">User & Installation manual VHF- Communication Transceiver</p>	<p>Doc.-Nr.: DE-3000-800100e</p>
	<p align="center">KRT2, KRT2M, KRT2RC</p>	<p align="right">Revision 13.0 Jul. 2016</p>

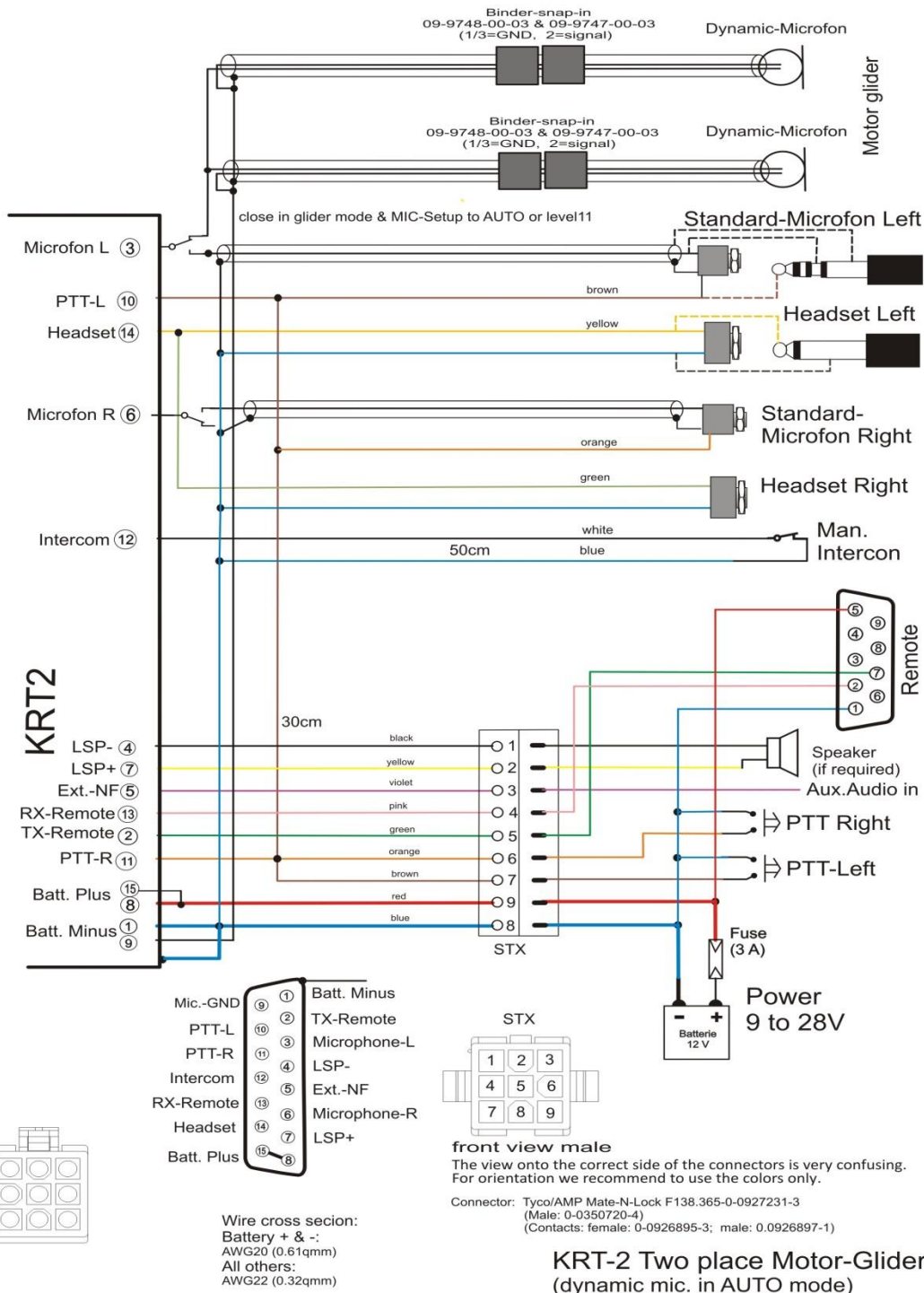
6.8.4.5 Motor glider dual-Dynamic Microphone Dynamic Microphone



Microphone-Setup: R for headsets, leave menu in AUTO mode.



	<p align="center">User & Installation manual VHF- Communication Transceiver</p>	<p>Doc.-Nr.: DE-3000-800100e</p>
	<p align="center">KRT2, KRT2M, KRT2RC</p>	<p align="right">Revision 13.0 Jul. 2016</p>

6.8.4.6 Motor glider dual-Electret Microphone

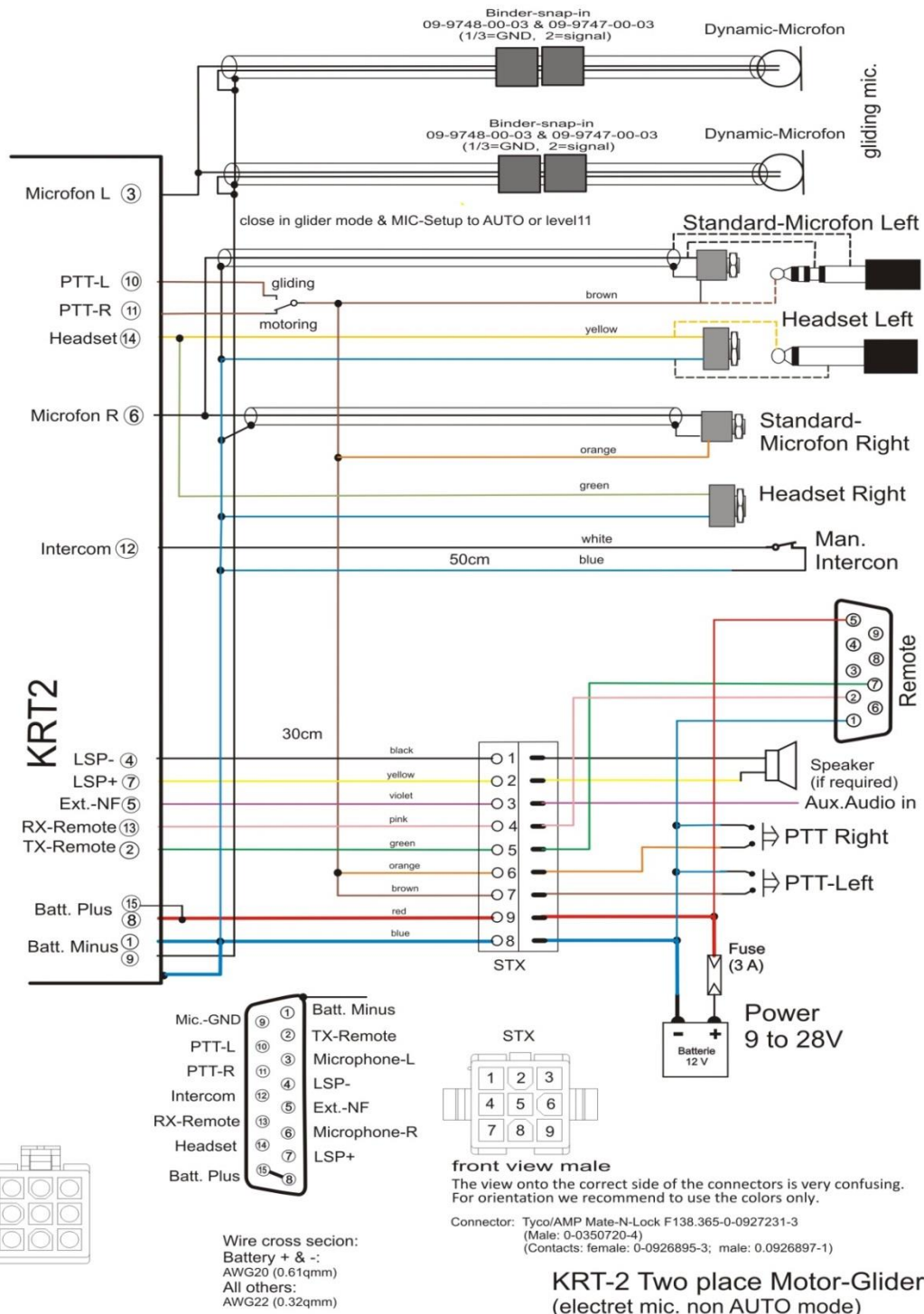
Electret Microphone



Microphone-Setup: leave L = 3..9 (in case of dynamic =11), R=3 (not AUTO-mode).

	User & Installation manual VHF- Communication Transceiver	Doc.-Nr.: DE-3000-800100e
	KRT2, KRT2M, KRT2RC	Revision 13.0 Jul. 2016

6.8.5 Wiring for dynamic microphones

Special attention is required for the wiring for dynamic microphones. Because of the required high gain any mistake on the ground wiring leads to interferences and feed backs.

The basic rules are:

- **Never connect the power current grounds with the microphone ground.**
- The cleanest GND is the case of the radio.
- Connect the battery-GND to the case and pin 1 and the microphone-GND to the pin 9 only (standard allocation).

6.8.6 Connection support

In order to get clean cable shields connections, and to avoid ground loops an adapter board as shown is recommended.

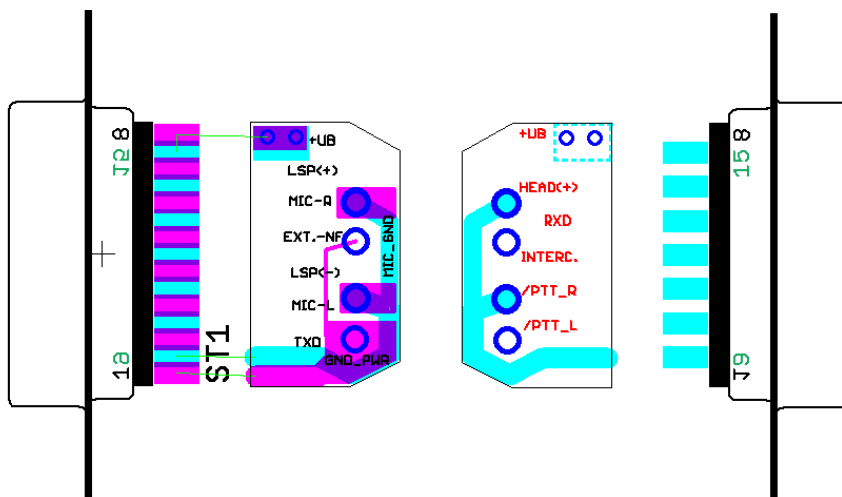



Figure 16: KRT2 Connection support

The adapter board is placed between the connector pin rows and soldered to GND pins 1 and frame.

Pin 9 (microphone-GND) has its dedicated connections for shielding.

	User & Installation manual VHF- Communication Transceiver	Doc.-Nr.: DE-3000-800100e
	KRT2, KRT2M, KRT2RC	Revision 13.0 Jul. 2016

6.9 Antenna



6.9.1 Antenna Selection

- A 50 Ohms impedance VHF-COM-antenna is required.
- The antenna must be approved in respect to aircraft type and installation location.
- The antenna specifications can only be fulfilled when properly installed

6.9.2 Installation Recommendation

- The manufactures instructions have to be observed.
- The metallic contact between airplane surface and antenna ground must be very good. Non-metallic airplanes must have installed a metal sheet, foil or mesh of at least 80×80 cm inside the fuselage as electric counterweight.
- In order to avoid interference the distance between a COM an NAV antenna or between a COM and another COM antenna should be as large as possible. A distance of 2 meters normally is sufficient.
- The antenna must be installed vertically and as far as possible from parts like propeller, landing-gear, rudder etc., that may influence propagation of the radio signals.
- In gliders the internal antenna provided by the airplane manufacturer is to be used.

	<p>The RF-antenna cable may not be part of other cable sets like power-supply or microphone.</p> <p>It must not be placed together with any other COM, NAV or transponder antenna cable.</p> <p>THIS IS VERY IMPORTANT</p>
---	---

	User & Installation manual VHF- Communication Transceiver	Doc.-Nr.: DE-3000-800100e
	KRT2, KRT2M, KRT2RC	Revision 13.0 Jul. 2016

6.10 Microphone general

The correct setting of the MIC and VOX values is of great importance for the Intercom system (see “4.4.3 VOX – Intercom Voice Trigger Level Setting” and “4.4.11 MIC – Setup”).

The VOX intercom voice trigger level must be set to such a value that the intercom system is activated when speaking at a normal voice level into the microphone. It should be set so that it is not triggered by normal cockpit noise.



In addition, VOX should be set to level 01 and the intercom switch permanently enabled.

The manual intercom operation is possible with one or two separate, optional parallel connected intercom switches. These switches are not the PTT switches. The intercom switches connect pin12 (intercom) with GND (pin1).

The intercom-deactivation will be indicated with “e” if pin12 is not on GND.

The intercom requires the connection pin 12 to GND either permanently or through the intercom switches.

Cockpit noise suppression is only possible with differential microphones used in modern headsets. Normal Electret microphones are not suitable.

	User & Installation manual VHF- Communication Transceiver	Doc.-Nr.: DE-3000-800100e
	KRT2, KRT2M, KRT2RC	Revision 13.0 Jul. 2016

6.11 Post-Installation Check

	A certified maintenance shop must verify the proper operation of the VHF transceiver or as required by national regulations.
---	--

A complete check of all airplane systems is required to certify that the new wiring is not causing any malfunction.

The standing wave ratio (SWR) must be less than 3:1.

A test flight is recommended to verify proper transceiver operation.

The following items should be checked:

- Check transceiver operation with a radio station at least 50 km away when at 2000ft or above.
- Check if there is unusual electrical interference or noise.
- If possible check the transceiver operation on low and high frequencies of the VHF frequency band.



6.12 Starting Up

Switch the unit on with the ON button.

The following display will appear:



The start display shows device type and the software number. It then changes into the normal operating mode (Direct Input).

	User & Installation manual VHF- Communication Transceiver	Doc.-Nr.: DE-3000-800100e
	KRT2, KRT2M, KRT2RC	Revision 13.0 Jul. 2016

6.13 Accessories

Suitable accessories such as antennas, cable sets, and switches can be purchased at our online shop on <http://www.dittel-avionik.de> or from other avionics suppliers.

	User & Installation manual VHF- Communication Transceiver	Doc.-Nr.: DE-3000-800100e
	KRT2, KRT2M, KRT2RC	Revision 13.0 Jul. 2016

6.14 Drawings

6.14.1 Dimensions

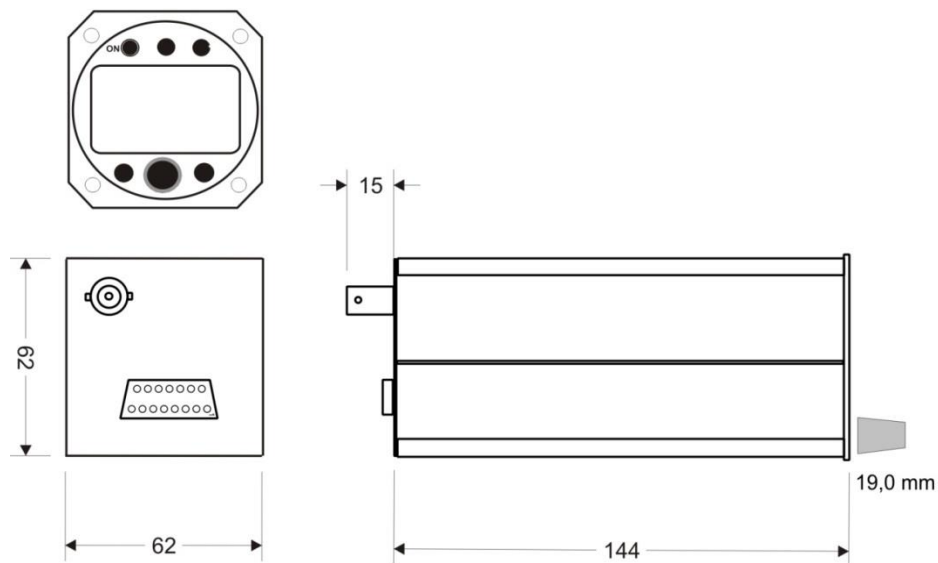

Figure 17: KRT2 Dimensions

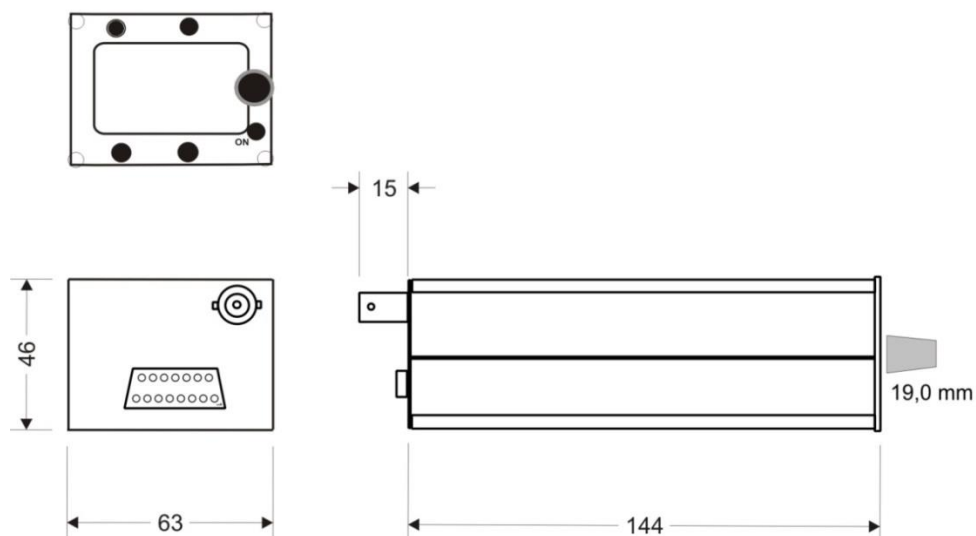



Figure 18: KRT2M "Mini" Dimensions

	User & Installation manual VHF- Communication Transceiver	Doc.-Nr.: DE-3000-800100e
	KRT2, KRT2M, KRT2RC	Revision 13.0 Jul. 2016

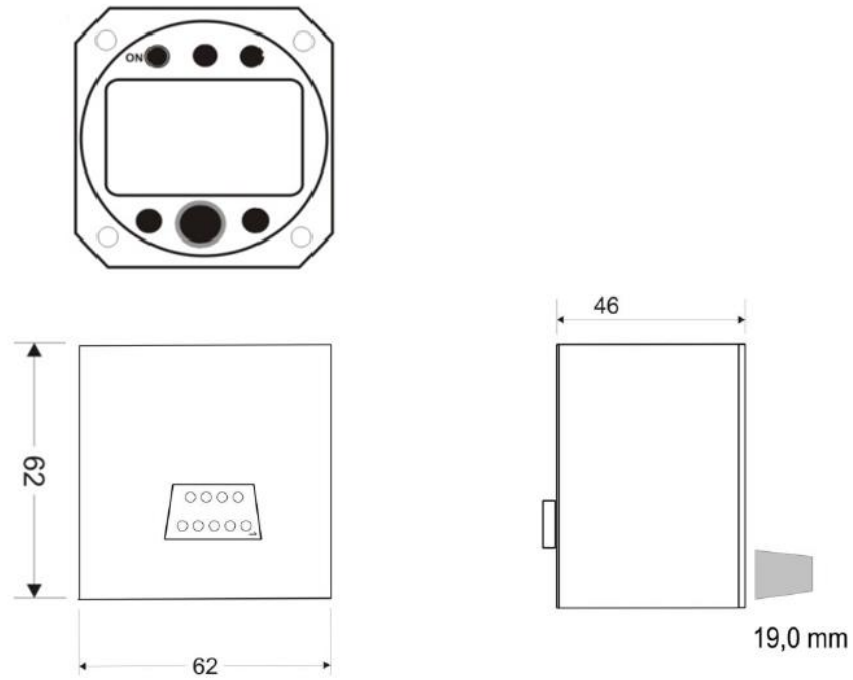

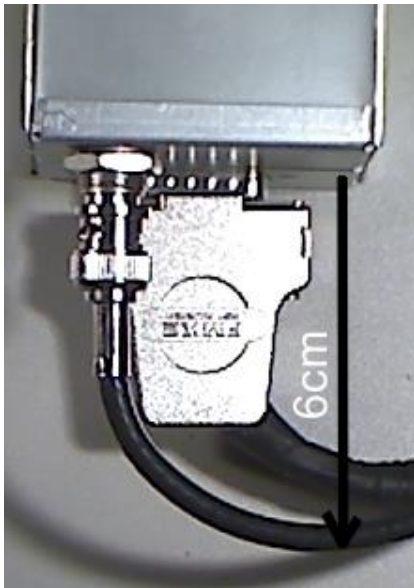

Figure 19: KRT2RC Remote Control Dimensions

	User & Installation manual VHF- Communication Transceiver	Doc.-Nr.: DE-3000-800100e
	KRT2, KRT2M, KRT2RC	Revision 13.0 Jul. 2016

6.14.2 Installation Directions



Connection Area

Figure 20: KRT2 Panel Cut out

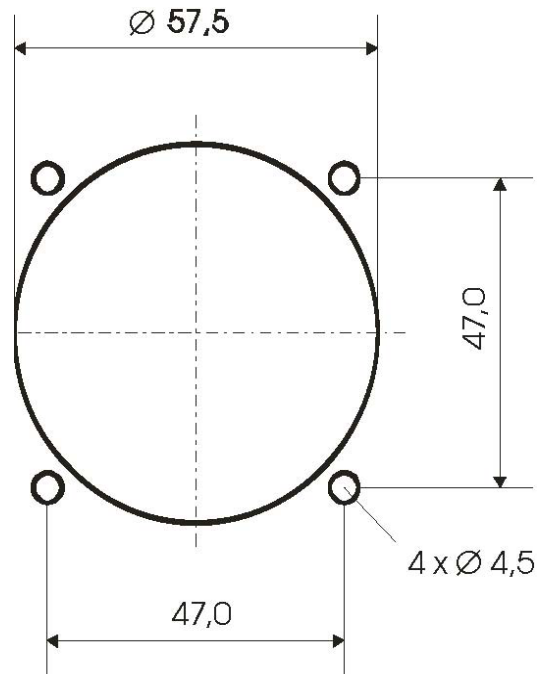

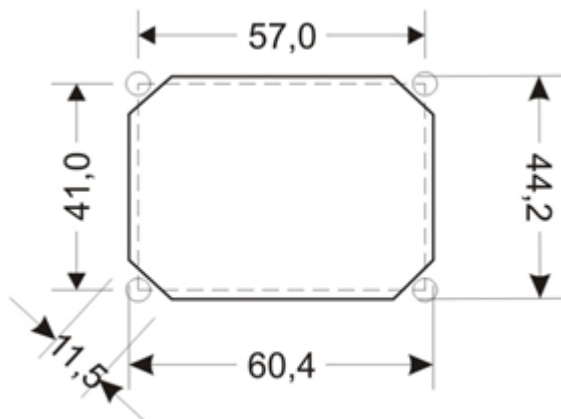

Panel Cut-out



Cut for mini case

Figure 21: KRT2M "Mini" Panel Cut out

	User & Installation manual VHF- Communication Transceiver	Doc.-Nr.: DE-3000-800100e
	KRT2, KRT2M, KRT2RC	Revision 13.0 Jul. 2016

7 Maintenance

7.1 Periodic Maintenance



There are no scheduled service tasks required on the KRT-2 VHF unit.

7.2 Repair

Only exchange and flat repair of the equipment is permitted. In case of equipment failure, the unit must be sent to the manufacturer. Refer to section “1.3 Customer Service”.

7.3 Cleaning

Clean the display only with, lint-free cloth and an eyeglass lens cleaner that is specified as safe for anti-reflective coatings.

	User & Installation manual VHF- Communication Transceiver	Doc.-Nr.: DE-3000-800100e
	KRT2, KRT2M, KRT2RC	Revision 13.0 Jul. 2016



8 ANNEX

8.1 Frequency / Channel- schedule

The following table contains the operating and displayed frequencies between 118.000 and 118.100MHz. The table can be continued up to 136.975 MHz following the same principle.



Operating frequency (MHz)	Channel Spacing (kHz)	Displayed channel 8.33/25 kHz Mode	Displayed Channel 25 kHz Mode
118.0000	25	118.000	118.000
118.0000	8.33	118.005	
118.0083	8.33	118.010	
118.0166	8.33	118.015	
118.0250	25	118.025	118.025
118.0250	8.33	118.030	
118.0333	8.33	118.035	
118.0416	8.33	118.040	
118.0500	25	118.050	118.050
118.0500	8.33	118.055	
118.0583	8.33	118.060	
118.0666	8.33	118.065	
118.0750	25	118.075	118.075
118.0750	8.33	118.080	
118.0833	8.33	118.085	
118.0916	8.33	118.090	
118.1000	25	118.100	118.100
118.1000	8.33	118.105	
etc.	etc.	etc.	etc.

Figure 22: Frequencies

	User & Installation manual VHF- Communication Transceiver	Doc.-Nr.: DE-3000-800100e
	KRT2, KRT2M, KRT2RC	Revision 13.0 Jul. 2016



8.2 Technical Data

GENERAL	
Approval Number	ETSO_210.10058303
Compliance Standards	ETSO-2C169a / TSO-C169a Transmitter: ED-23C Class 4,6 / DO-186B, Class 4,6 Receiver: ED-23C Class C-D-E-H1/2 / DO-186B, Class C-D-E
Standards	EUROCAE ED-23C / RTCA DO-186B RTCA DO-160F/ED14F RTCA DO-178B/ED12B Software Level D
Dimensions 57mm-case	Height: 62mm, Width: 62 mm Depth: 146mm plus rear panel plugs 60mm
Dimensions Portrait	Height: 64mm, Width: 46 mm Depth: 150mm plus rear panel plugs 60mm
Dimensions Landscape	Height: 46mm, Width: 64 mm Depth: 150mm plus rear panel plugs 60mm
Weight 57mm Portrait / Landscape	0.36 kg 0.34 kg
Mounting	Panel mounting, cut-out Ø 57 mm or chapter "Figure 21: KRT2M "Mini" Panel Cut out"
Temperature Ranges Operation Storage	-20 °C to +55 °C -55 °C to +85 °C
Maximum Height	35000ft
Vibration	DO-160E, Cat. S, Vibration Curve M
Humidity	RTCA DO-160E, Cat. A
Shock	6 G operation 20 G crash safety
RTCA DO-160F ENV. CAT.	[C4Z]CAB[SM]XXXXXXZBAB[AC]YMXXXAX

	User & Installation manual VHF- Communication Transceiver	Doc.-Nr.: DE-3000-800100e
	KRT2, KRT2M, KRT2RC	Revision 13.0 Jul. 2016

GENERAL	
Power Supply	9 VDC to 33VDC test @ 13.8VDC <ul style="list-style-type: none"> • Transmitter: 2.0 A (typ.) • Receiver: 0.13 A • Illumination 0.01A to 0.07A • Audio Power amp. Up to 1A
Power Consumption	emergency operation: 9 VDC Standby 1.6W, Transmit 30 W
Frequency Range	118.000 to 136.995 MHz
Frequency Stability	±5 ppm
Fuse	external fuse required: 3 A, slow-blow
Compass Safe Distance	30 cm

Figure 23: Technical Data

	User & Installation manual VHF- Communication Transceiver	Doc.-Nr.: DE-3000-800100e
	KRT2, KRT2M, KRT2RC	Revision 13.0 Jul. 2016

TRANSMITTER	
Power Output	6 W (nominal) @ >13.5V 4 W (minimal)
Harmonic Distortion	<10 % at 70 % modulation
Sidetone Output	>0,5W an 300Ω (head set output)
Microphone Inputs	2 x standard (50mV...2V) into 100Ω or 2 x dynamic
Harmonic Content	>60dBc
Modulation Fidelity	deviation <6 dB von 350...2500Hz
Carrier Noise Level	>35dB at 70% Modulation index
Unwanted Frequency Modulation	<1kHz at m=70% / 1kHz
Duty Cycle	2 minutes on, 4 minutes off; automatic turn-off after 2 minutes continuous transmitter operation
RECEIVER	
Sensitivity	-105 dBm (>6 dB S+N/N, m = 30 % / 1 kHz)
Bandwidth / 25 KHZ	-6-dB-bandwidth > ±8.0 kHz
Bandwidth / 8.33 KHZ	-6-dB-bandwidth > ±2.78 kHz
Selectivity (channel spacing 25 KHZ)	-40-dB-bandwidth < ±17.0 kHz -60-dB-bandwidth < ±22.0 kHz
Selectivity (channel spacing 8.33 KHZ)	-60-dB-bandwidth < ±7.37 kHz
Speaker Output	≥10 W into 4 Ω
AGC Characteristics	Deviation of NF-output < 6 dB from 10 μV to 10 mV
Squelch	Automatic Squelch (adjustable)
Spurious Responses	> 80 dB
Distortion (350...2500Hz)	<25% at rated power (85% / -33dBm) <10% at 10dB below rated power (70% / -33dBm)

Figure 24: Transmitter/Receiver