



MB-SMARC-1 User's Manual

MB-SMARC-1 UM 0102
2020-06-04

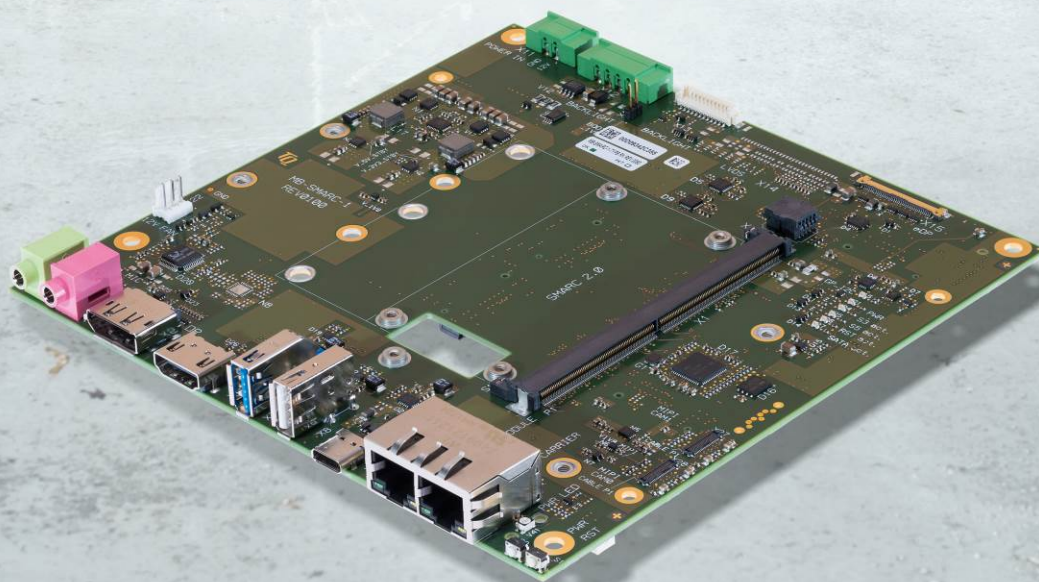



TABLE OF CONTENTS

1.	ABOUT THIS MANUAL.....	1
1.1	Copyright and Licence Expenses.....	1
1.2	Registered Trademarks.....	1
1.3	Disclaimer.....	1
1.4	Imprint.....	1
1.5	Service and Support.....	1
1.6	Tips on Safety.....	2
1.7	Symbols and Typographic Conventions.....	2
1.8	Handling and ESD Tips.....	2
1.9	Naming of Signals.....	3
1.10	Further Applicable Documents / Presumed Knowledge.....	3
2.	INTRODUCTION.....	4
2.1	Functional Overview.....	4
2.2	Compliance.....	4
2.3	Accessories.....	4
3.	ELECTRONICS.....	5
3.1	Block Diagram.....	5
3.2	Power Supply.....	6
3.2.1	Supply Voltage Characteristics.....	6
3.2.2	Power Consumption Specification.....	6
3.3	Environmental Specification.....	6
3.4	System Components.....	6
3.4.1	Gigabit Ethernet Controller.....	6
3.4.2	HD-Audio.....	6
3.5	Connectors and Interfaces.....	7
3.5.1	Power Supply, X11.....	9
3.5.2	DisplayPort, X5.....	9
3.5.3	HDMI, X6.....	9
3.5.4	USB Host Interfaces, X7, X8, X9, X40.....	9
3.5.5	Gigabit Ethernet, X10.....	10
3.5.6	Serial Interfaces (RS-232), X33 to X36.....	10
3.5.7	Embedded Display Port, X15.....	11
3.5.8	LVDS, X14.....	12
3.5.9	MIPI CSI (Camera serial interface), X27, X28.....	14
3.5.10	M.2 Socket with E-Keying (for I/O devices), X43.....	15
3.5.11	M.2 Socket with B-Keying (for WWAN devices), X32.....	15
3.5.12	M.2 Socket with B-Keying (for SSD devices), X44.....	15
3.5.13	M.2 Socket with M-Keying (for SSD devices), X42.....	15
3.5.14	µSD Card, X30.....	15
3.5.15	Audio.....	15
3.5.16	Fan Connector, X22.....	15
3.5.17	Power and Reset Button Connector, X45.....	16
3.5.18	SPI Flash Socket, X17.....	16
3.5.19	SMARC Connector, X1.....	16
3.5.20	GPIO Header, X38.....	16
3.5.21	Power LED, V41.....	17
3.5.22	Debug LEDs.....	17



TABLE OF CONTENTS (continued)

4.	MECHANICS.....	18
4.1	Dimensions.....	18
4.2	Protection against External Effects.....	18
5.	SOFTWARE.....	19
5.1	System Resources.....	19
5.1.1	General Purpose I ² C Bus.....	19
5.1.2	SMBus / Power Management I ² C Bus.....	19
5.2	Operating Systems.....	19
5.2.1	Supported Operating Systems.....	19
5.2.2	Driver Download.....	19
6.	SAFETY REQUIREMENTS AND PROTECTIVE REGULATIONS.....	20
6.1	EMC.....	20
6.2	ESD.....	20
6.3	Operational Safety and Personal Security.....	20
6.4	Reliability and Service Life.....	20
6.5	Environment protection.....	20
6.5.1	RoHS.....	20
6.5.2	WEEE®.....	20
6.5.3	REACH®.....	20
6.5.4	EuP.....	20
6.5.5	Packaging.....	20
6.6	Battery.....	21
6.6.1	General notes.....	21
6.6.2	Lithium batteries.....	21
6.7	Other Entries.....	21
7.	APPENDIX.....	22
7.1	Acronyms and Definitions.....	22
7.2	References.....	24



TABLE DIRECTORY

Table 1:	Terms and Conventions.....	2
Table 2:	Pinout Power-In connector, X11.....	9
Table 3:	Pinout on-board USB connector, X40.....	9
Table 4:	Function of Ethernet LEDs.....	10
Table 5:	RS-232 D-Sub Connector.....	10
Table 6:	eDP Connector, X15.....	11
Table 7:	LVDS Connector, X14.....	12
Table 8:	Backlight Power Connector, X12.....	13
Table 9:	Backlight Connector, X13.....	13
Table 10:	MIPI CSI Connectors, X27, X28.....	14
Table 11:	12 V Fan Connector, X22.....	15
Table 12:	Power and Reset Button Connector, X45.....	16
Table 13:	GPIO Header, X38.....	16
Table 14:	Power LED, V41.....	17
Table 15:	Debug LEDs.....	17
Table 16:	I ² C Address Mapping General Purpose I ² C Bus.....	19
Table 17:	Acronyms.....	22
Table 18:	Further Applicable Documents and Links.....	24

ILLUSTRATION DIRECTORY

Illustration 1:	Block Diagram MB-SMARC-1.....	5
Illustration 2:	MB-SMARC-1, Top.....	7
Illustration 3:	MB-SMARC-1, Bottom.....	8
Illustration 4:	DC Power Supply Connector, X11.....	9
Illustration 5:	On-board USB connector, X40.....	9
Illustration 6:	RJ45 Connectors, X10.....	10
Illustration 7:	RS-232 D-SUB Connector.....	10
Illustration 8:	eDP Connector, X15.....	11
Illustration 9:	LVDS Connector, X14.....	12
Illustration 10:	Backlight Power Connector, X12.....	13
Illustration 11:	Backlight Connector, X13.....	13
Illustration 12:	MIPI CSI Connectors, X27, X28.....	14
Illustration 13:	12 V Fan Connector, X22.....	15
Illustration 14:	PWR and RST Button, X45.....	16
Illustration 15:	GPIO header, X38.....	16
Illustration 16:	MB-SMARC-1 dimensions.....	18

REVISION HISTORY

Rev.	Date	Name	Pos.	Modification
0100	2018-01-27	FP		First edition
0101	2018-10-30	FP	All Table 5, Table 7, Table 8 6.5, 6.5.3, 6.5.4, 6.5.5, 6.6	Links updated "BLKT" corrected to "BKLT" Added
0102	2020-06-04	FP	All Illustration 2, Illustration 3 Table 13	Non-functional changes, formatting Connector numbers added Added



1. ABOUT THIS MANUAL

1.1 Copyright and Licence Expenses

Copyright protected © 2020 by TQ-Systems GmbH.

This User's Manual may not be copied, reproduced, translated, changed or distributed, completely or partially in electronic, machine readable, or in any other form without the written consent of TQ-Systems GmbH.

The drivers and utilities for the components used as well as the BIOS are subject to the copyrights of the respective manufacturers. The licence conditions of the respective manufacturer are to be adhered to.

BIOS-licence expenses are paid by TQ-Systems GmbH and are included in the price.

Licence expenses for the operating system and applications are not taken into consideration and must be calculated / declared separately.

1.2 Registered Trademarks

TQ-Systems GmbH aims to adhere to copyrights of all graphics and texts used in all publications, and strives to use original or license-free graphics and texts.

All brand names and trademarks mentioned in this User's Manual, including those protected by a third party, unless specified otherwise in writing, are subjected to the specifications of the current copyright laws and the proprietary laws of the present registered proprietor without any limitation. One should conclude that brand and trademarks are rightly protected by a third party.

1.3 Disclaimer

TQ-Systems GmbH does not guarantee that the information in this User's Manual is up-to-date, correct, complete or of good quality. Nor does TQ-Systems GmbH assume guarantee for further usage of the information. Liability claims against TQ-Systems GmbH, referring to material or non-material related damages caused, due to usage or non-usage of the information given in this User's Manual, or due to usage of erroneous or incomplete information, are exempted, as long as there is no proven intentional or negligent fault of TQ-Systems GmbH.

TQ-Systems GmbH explicitly reserves the rights to change or add to the contents of this User's Manual or parts of it without special notification.

1.4 Imprint

TQ-Systems GmbH
Gut Delling, Mühlstraße 2
D-82229 Seefeld

Tel: +49 (0) 8153 9308-0

Fax: +49 (0) 8153 9308-4223

E-Mail: Info@TQ-Group

Web: TQ-Group

1.5 Service and Support

Please visit our website TQ-Group for latest product documentation, drivers, utilities and technical support.

You can register on our website TQ-Group to have access to restricted information and automatic update services.

For direct technical support you can contact our FAE team by email: TQ-Support.

Our FAE team can also support you with additional information like 3D-STEP files and confidential information, which is not provided on our public website.





For service or RMA, please contact our service team by email (TQ-Service) or your sales team at TQ.

1.6 Tips on Safety

Improper or incorrect handling of the product can substantially reduce its life span.

1.7 Symbols and Typographic Conventions

Table 1: Terms and Conventions

Symbol	Meaning
	This symbol represents the handling of electrostatic-sensitive modules and / or components. These components are often damaged / destroyed by the transmission of a voltage higher than about 50 V. A human body usually only experiences electrostatic discharges above approximately 3,000 V.
	This symbol indicates the possible use of voltages higher than 24 V. Please note the relevant statutory regulations in this regard. Non-compliance with these regulations can lead to serious damage to your health and also cause damage / destruction of the component.
	This symbol indicates a possible source of danger. Acting against the procedure described can lead to possible damage to your health and / or cause damage / destruction of the material used.
	This symbol represents important details or aspects for working with TQ-products.
Command	A font with fixed-width is used to denote commands, contents, file names, or menu items.

1.8 Handling and ESD Tips

General handling of your TQ-products

	<p>The TQ-product may only be used and serviced by certified personnel who have taken note of the information, the safety regulations in this document and all related rules and regulations.</p> <p>A general rule is: do not touch the TQ-product during operation. This is especially important when switching on, changing jumper settings or connecting other devices without ensuring beforehand that the power supply of the system has been switched off.</p> <p>Violation of this guideline may result in damage / destruction of the MB-SMARC-1 module and be dangerous to your health.</p> <p>Improper handling of your TQ-product would render the guarantee invalid.</p>
---	---

Proper ESD handling

	<p>The electronic components of your TQ-product are sensitive to electrostatic discharge (ESD).</p> <p>Always wear antistatic clothing, use ESD-safe tools, packing materials etc., and operate your TQ-product in an ESD-safe environment. Especially when you switch modules on, change jumper settings, or connect other devices.</p>
---	--



1.9 Naming of Signals

A hash mark (#) at the end of the signal name indicates a low-active signal.

Example: RESET#

If a signal can switch between two functions and if this is noted in the name of the signal, the low-active function is marked with a hash mark and shown at the end.

Example: C / D#

If a signal has multiple functions, the individual functions are separated by slashes when they are important for the wiring.

The identification of the individual functions follows the above conventions.

Example: WE2# / OE#

1.10 Further Applicable Documents / Presumed Knowledge

- **Specifications and manual of the modules used:**
These documents describe the service, functionality and special characteristics of the module used.
- **Specifications of the components used:**
The manufacturer's specifications of the components used, for example CompactFlash cards, are to be taken note of. They contain, if applicable, additional information that must be taken note of for safe and reliable operation. These documents are stored at TQ-Systems GmbH.
- **Chip errata:**
It is the user's responsibility to make sure all errata published by the manufacturer of each component are taken note of. The manufacturer's advice should be followed.
- **Software behaviour:**
No warranty can be given, nor responsibility taken for any unexpected software behaviour due to deficient components.
- **General expertise:**
Expertise in electrical engineering / computer engineering is required for the installation and the use of the device.

Implementation information for the carrier board design is provided in the SMARC Design Guide (2) maintained by the SGET.

This Carrier Design Guide includes a good guideline to design a SMARC carrier board.

It includes detailed information with schematics and detailed layout guidelines.

Please refer to the official SGET documentation for additional information (1), (2).



2. INTRODUCTION

The SMARC mainboard MB-SMARC-1 is a carrier board for SMARC modules with a pinout based on the SMARC 2.0 specification. It can be used for panel PCs, embedded computers or as evaluation platform for SMARC modules.

In combination with a standard SMARC module it forms a very compact hardware kit that can be used for a freely scalable embedded PC platform thanks to its modular design. Because of this – with uniform interfaces and dimensions – the PC system can be easily adapted to suit the requirements of the application. The many extension options and storage media, which can be added, offer a high level of flexibility and allow functionalities and performance to be extended easily, quickly and inexpensively. Typical usage is in embedded server applications, PC systems, automation, visualisation and monitoring and all applications that place high demands on quality, durability and long-term availability.

2.1 Functional Overview

The following key functions are implemented on the MB-SMARC-1:

Supported Modules:

- SMARC Modules with pinout based on SMARC 2.0 specification

External Interfaces:

- 2 × Gigabit Ethernet
- USB: 1 × USB 2.0; 1 × USB 3.0; 1 × USB Type-C
- 1 × HDMI
- 1 × DisplayPort
- Audio (headphone out and microphone in)
- Power Button / Reset

Internal Interfaces:

- LVDS or eDP
- 1 × USB
- M.2 socket with E-Keying (e.g. for WLAN / Bluetooth cards)
- M.2 socket with B-Keying (e.g. for WWAN cards) (with Micro SIM Card support)
- M.2 socket with B-Keying (for SATA based SSDs)
- M.2 socket with M-Keying (for PCIe based SSDs)
- Socket for µSD cards
- 4 × RS-232
- 2 × MIPI CSI (Camera Serial Interface)

Power supply:

- Voltage: 12 V DC ±5 %

Environment:

- Extended temperature: –20 °C to +85 °C

Form factor / dimensions:

- 170 × 170 mm² (Mini ITX)

2.2 Compliance

The MB-SMARC-1 supports SMARC modules, which are compliant to SGET SMARC Hardware Specification (V2.0).

2.3 Accessories

- **DK-USB-TYPA-MOL5**
Adapter cable from internal USB connector to an A-Type receptacle, 150 mm long
Order code: 277130.0100
- **DSUB-ADAPTER DK-RS-232-9POL-DSUB-PICOBLADE**
Adapter cable from internal connector to a 9-pin D-Sub male connector, 150 mm long
Order code: 278622.0100

Please contact [TQ-Support](#) for details about DisplayPort cables and DisplayPort to DVI/HDMI adapters.

3. ELECTRONICS

3.1 Block Diagram

The following illustration shows the block diagram of the MB-SMARC-1:

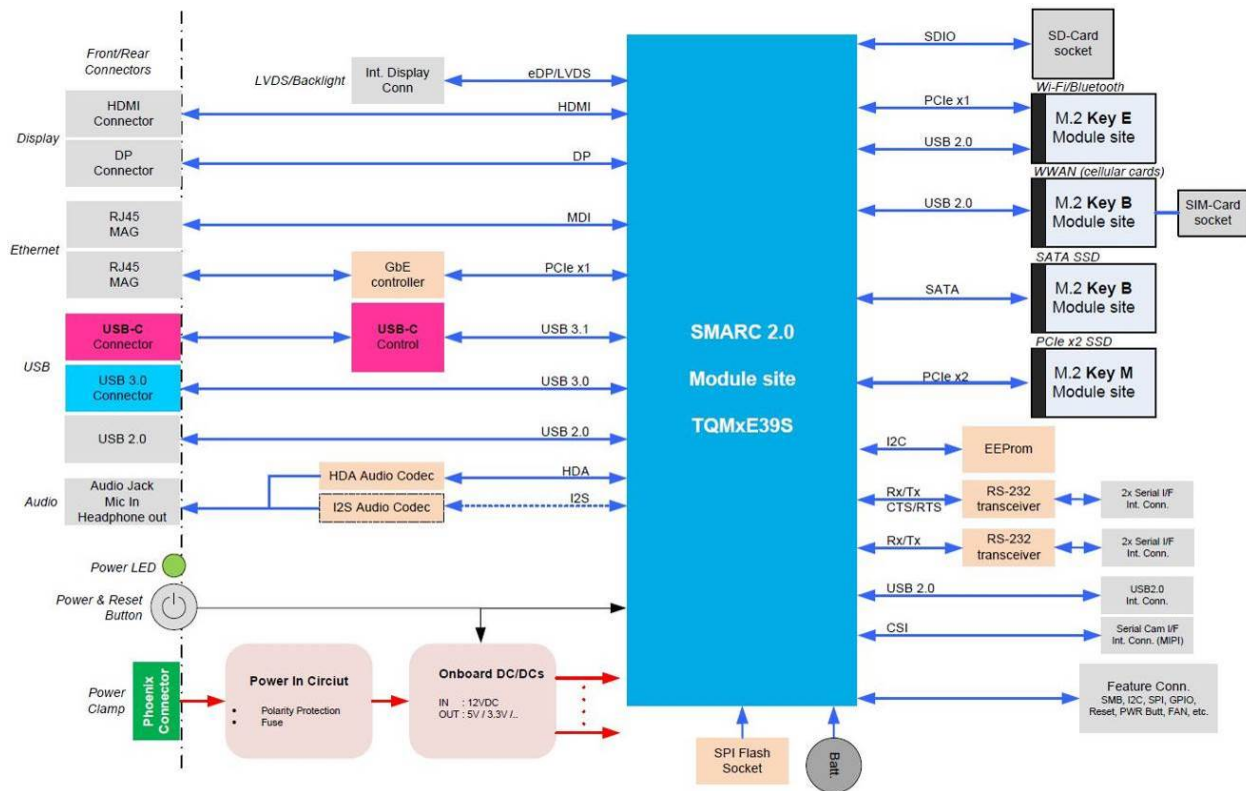

Illustration 1: Block Diagram MB-SMARC-1

3.2 Power Supply

3.2.1 Supply Voltage Characteristics

The MB-SMARC-1 requires an input voltage of 12 V DC $\pm 5\%$.

The input voltages shall rise from 10 % of nominal to 90 % of nominal within 0.1 msec to 20 msec.
(0.1 msec \leq Rise Time \leq 20 msec)

There must be a smooth and continuous increase of each DC output voltage from 10 % to 90 % of its final set point within the regulation range.

3.2.2 Power Consumption Specification

The power consumption of the system significantly depends on the connected devices (SMARC module, Mass storage devices, USB devices, display backlight etc.).

The power consumption of the MB-SMARC-1 itself is approximately 1.9 W (SMARC module supplied externally; UEFI-shell active; no keyboard, no mouse, no mass storage device, no Ethernet cable etc. connected).

The maximum input current of the MB-SMARC-1 is limited to 5 A by a fuse. The load caused by devices connected to the carrier board should not exceed 40 W.

Note: Power requirement



The power supply for the MB-SMARC-1 must be configured with enough reserve.
It should be calculated with the maximum power of all connected components.

3.3 Environmental Specification

- Operating temperature, extended: $-20\text{ }^{\circ}\text{C}$ to $+85\text{ }^{\circ}\text{C}$
- Storage temperature: $-40\text{ }^{\circ}\text{C}$ to $+85\text{ }^{\circ}\text{C}$
- Relative humidity (operating / storage): 10 % to 90 % (not condensing)

3.4 System Components

3.4.1 Gigabit Ethernet Controller

The MB-SMARC-1 provides an Intel® i210IT Ethernet controller with 10/100/1000 Mbps speed and IEEE1588 support.

Please contact [TQ-Support](#) for further information about the IEEE1588 support.

3.4.2 HD-Audio

The MB-SMARC-1 provides a Realtec ALC262 High Definition Audio Codec and is equipped with audio jacks for microphones and headphones.

3.5 Connectors and Interfaces

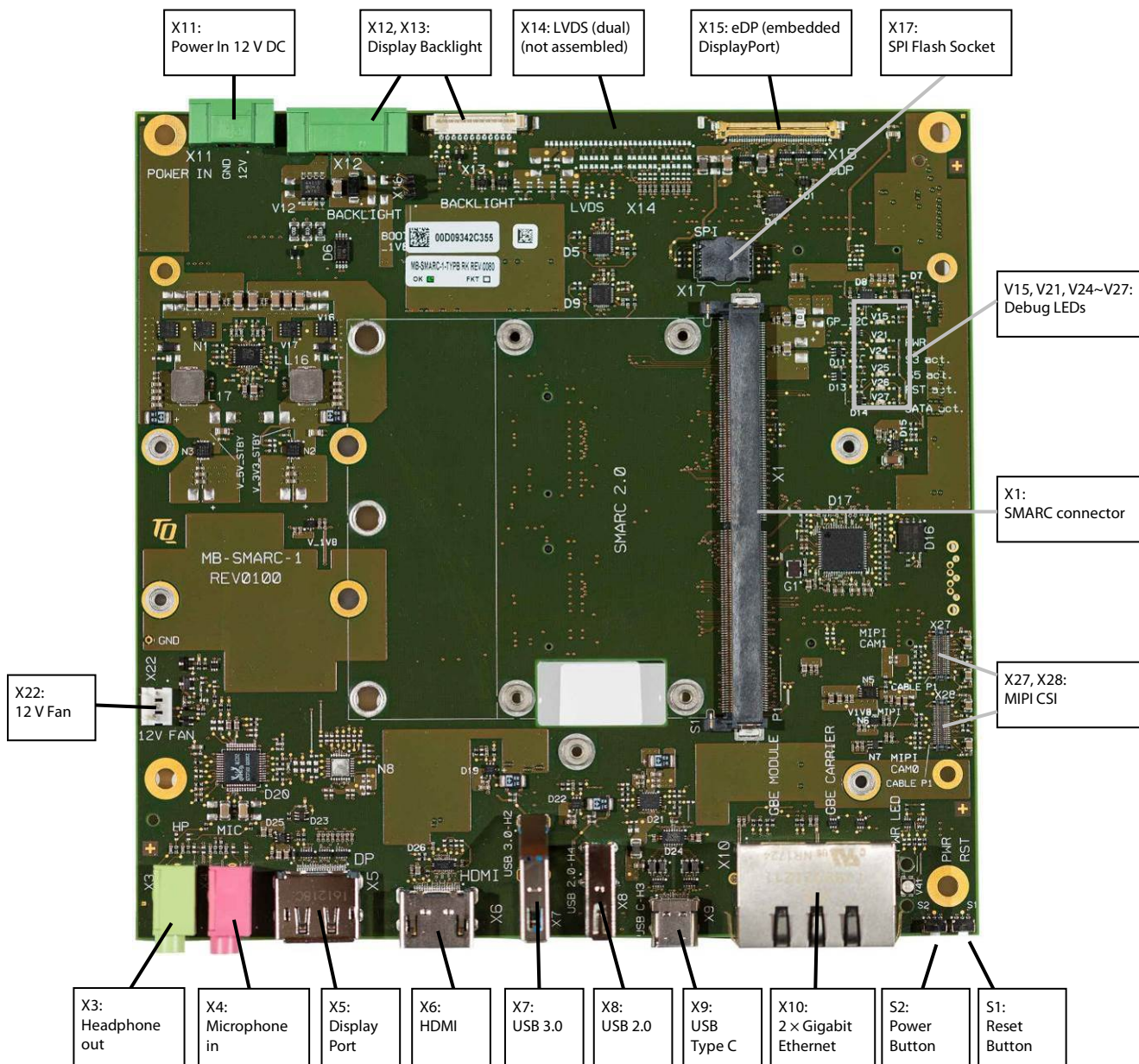

Illustration 2: MB-SMARC-1, Top

3.5 Connectors and Interfaces (continued)

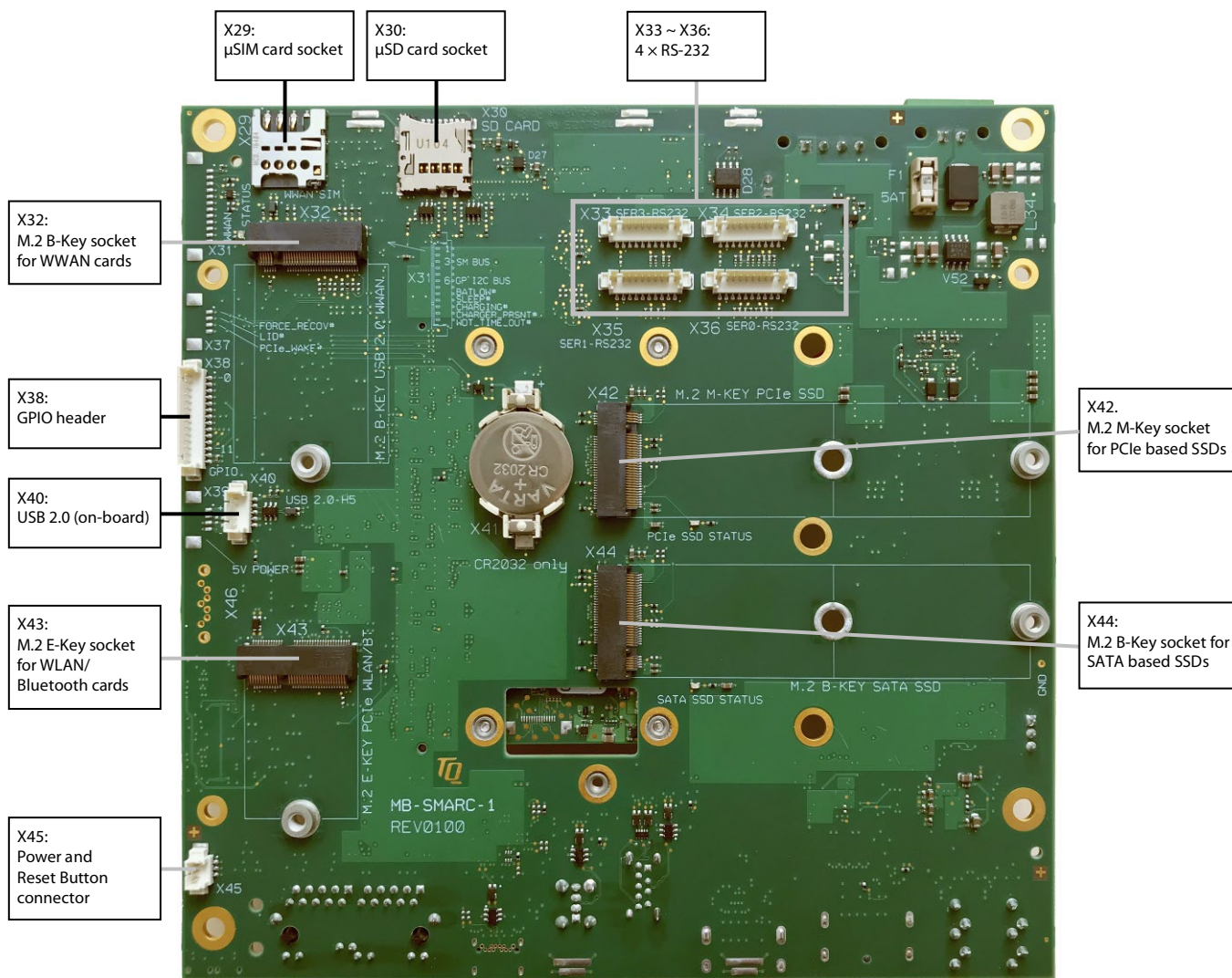

Illustration 3: MB-SMARC-1, Bottom

3.5.1 Power Supply, X11

The MB-SMARC-1 requires a single 12 V DC power supply. The voltage should not vary more than $\pm 5\%$.

Power-In connector:

- Connector type: Phoenix MC 1,5/ 2-GF-3,5-LR (1817615)
- Mating connector: e.g. Phoenix FMC 1,5/ 2-STF-3,5 (1966091)

Table 2: Pinout Power-In connector, X11

Pin	Signal	Remark
1	12 V	Fused @ 5 A
2	GND	-

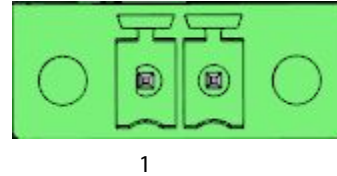

Illustration 4: DC Power Supply Connector, X11

3.5.2 DisplayPort, X5

The MB-SMARC-1 supports one DisplayPort interface.

The support of the interface and adapters from DP to HDMI, DVI or VGA depends on the combination of the SMARC module and the adapter used. The combination of some modules with some adapters might not work.

3.5.3 HDMI, X6

The MB-SMARC-1 supports one HDMI interfaces.

The support of the interfaces and possible adapters depends on the combination of the SMARC module and the adapter used. The combination of some modules with some adapters might not work.

3.5.4 USB Host Interfaces, X7, X8, X9, X40

The MB-SMARC-1 supports several USB Host interfaces.

USB 3 Front connector X7: For direct usage of a USB 3.1 Gen1 host port (up to 0.9 A @ 5 V)

USB 2 Front connector X8: For direct usage of a USB 2.0 host port (up to 0.9 A @ 5 V)

USB Type-C connector X9: For direct usage of a USB 3.1 Gen1 host port (up to 3 A @ 5 V)

On-board USB connector X40: For usage of a USB 2.0 host port with an adapter cable (see chapter Accessories)

- Connector type: Molex 53398-0571
- Mating connector: Molex 51021-0500

Table 3: Pinout on-board USB connector, X40

Pin	Signal	Remark / cable colour
1	+5 V	Red
2	D-	White
3	D+	Green
4	GND	Black
5	GND	-

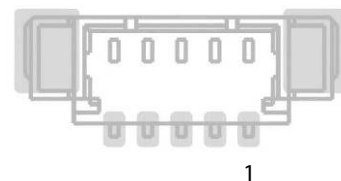

Illustration 5: On-board USB connector, X40

3.5.5 Gigabit Ethernet, X10

The MB-SMARC-1 supports two common Gigabit Ethernet ports. An Intel® i210IT Ethernet controller with 10/100/1000 Mbps speed implemented on the MB-SMARC-1. For the other Ethernet port the Ethernet signals of the SMARC module are used.

Table 4: Function of Ethernet LEDs

LED Colour	Function
Green	Link is up (Link is connected)
Orange / Yellow	Act (Blinks at data transfer)

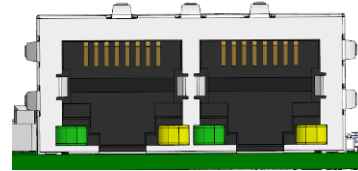

Illustration 6: RJ45 Connectors, X10

3.5.6 Serial Interfaces (RS-232), X33 to X36

The MB-SMARC-1 supports four serial ports:

- RS-232 port at on-board connectors X33 to X36

The SMARC specification does provide following signal definitions for the serial ports:

- Rx / Tx / RTS / CTS for port 0 and 2
- Rx / Tx for port 1 and 3

RS-232 connector: For usage of the RS-232 ports with an adapter cable (see chapter Accessories)

- Connector type: Molex 53398-1071
- Mating connector: Molex 51021-1000

Table 5: RS-232 D-Sub Connector

Pin	RS-232 Signal (all signals)	MB-SMARC-1	D-Sub connector (with DSUB-Adaptor)
1	DCD	NC	-
2	DSR	NC	RXD
3	RXD	RXD	TXD
4	RTS	RTS	-
5	TXD	TXD	GND
6	CTS	CTS	-
7	DTR	NC	RTS
8	RI	NC	CTS
9	GND	GND	-
10	-	NC	-

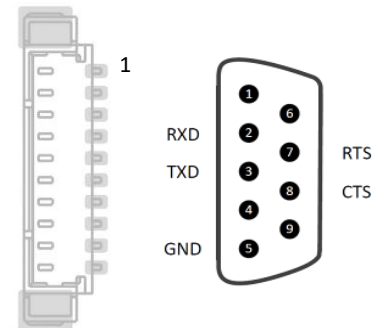

Illustration 7: RS-232 D-SUB Connector

3.5.7 Embedded Display Port, X15

The MB-SMARC-1 supports an embedded DisplayPort (eDP) interface where suitable displays can be connected directly. This functionality is only available with an eDP variant of the MB-SMARC-1 and if the connected SMARC module supports eDP. LVDS is not available with the eDP variant.

Please contact [TQ-Support](#) for further information about eDP or LVDS support.

eDP connector:

- Connector type: JAE HD1S040HA1
- Mating connector: JAE HD1P040MA1

Table 6: eDP Connector, X15

Pin	Signal	Remark
1	NC	–
2	GND	–
3	TX3–	Lane 3 differential pair
4	TX3+	
5	GND	–
6	TX2–	Lane 2 differential pair
7	TX2+	
8	GND	–
9	TX1–	Lane 1 differential pair
10	TX1+	
11	GND	–
12	TX0–	Lane 0 differential pair
13	TX0+	
14	GND	–
15	AUX+	AUX - channel
16	AUX–	
17	GND	–
18	3V3	3.3 V supply voltage
19	3V3	
20	3V3	
21	3V3	
22	NC	–
23	GND	–
24	GND	
25	GND	
26	GND	
27	HPD	Hot Plug Detect
28	GND	–
29	GND	
30	GND	
31	GND	
32	BKLT_EN	Backlight enable
33	BKLT_CTRL	Backlight (brightness) control
34	VDD_EN	Panel power enable
35	AUX_SEL	No function
36	V_BKLT	12 V Backlight supply voltage
37	V_BKLT	
38	V_BKLT	
39	V_BKLT	
40	NC	–

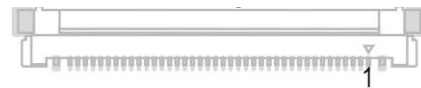

Illustration 8: eDP Connector, X15

3.5.8 LVDS, X14

The MB-SMARC-1 supports an LVDS interface where suitable displays can be connected directly. This functionality is only available with an LVDS variant of the MB-SMARC-1 and if the connected SMARC module supports LVDS. eDP is not available with the LVDS variant.

There are also connectors to power the backlight of the connected display.

The MB-SMARC-1 has an on-board EDID EEPROM to store display specific timing information.

This EEPROM can be programmed with an external I²C programmer.

If the programmer supports 3.3 V output voltage, the MB-SMARC-1 can be programmed without any additional power supply.

In this case no SMARC module should be connected to the carrier board.

LVDS connector

- Connector type: Hirose DF19G-30P-1H
- Mating connector: Hirose DF19-30S-1C

Table 7: LVDS Connector, X14

Pin	Signal	Remark
1	A0-	Odd bus
2	A0+	Odd bus
3	A1-	Odd bus
4	A1+	Odd bus
5	A2-	Odd bus
6	A2+	Odd bus
7	GND	-
8	ACLK-	Odd bus
9	ACLK+	Odd bus
10	A3-	Odd bus
11	A3+	Odd bus
12	B0-	Even bus
13	B0+	Even bus
14	GND	-
15	B1-	Even bus
16	B1+	Even bus
17	GND	-
18	B2-	Even bus
19	B2+	Even bus
20	BCLK-	Even bus
21	BCLK+	Even bus
22	B3-	Even bus
23	B3+	Even bus
24	GND	-
25	5V_PANEL	5 V Panel supply voltage
26	5V_PANEL	
27	5V_PANEL	
28	3V3_PANEL	3.3 V Panel supply voltage
29	3V3_PANEL	
30	3V3_PANEL	



Illustration 9: LVDS Connector, X14

3.5.8 LVDS, X14 (continued)

Backlight Power connector, X12

- Connector type: Phoenix MC 1,5/ 4-GF-3,5-LR (1817631)
- Mating connector: e.g. Phoenix FMC 1,5/ 4-STF-3,5 (1966114)

Table 8: Backlight Power Connector, X12

Pin	Signal	Remark
1	12V_BL	12 V always-on output
2	VCC_IN ¹	Backlight voltage input
3	GND	–
4	VCC_BKLT_OUT	Backlight voltage output

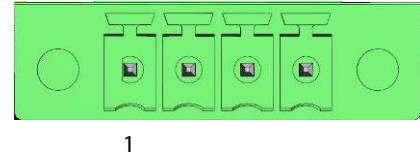

Illustration 10: Backlight Power Connector, X12

Backlight connector, X13

- Connector type: Molex 53398-1271
- Mating connector: Molex 51021-1200

Table 9: Backlight Connector, X13

Pin	Signal	Remark
1	V_BKLT_OUT	12 V switched output
2		
3		
4	GND	–
5		
6		
7	NC	–
8	BLEN	Backlight Enable output
9	BLT_CTRL	Backlight (brightness) control
10	3V3_PROG ²	3.3 V input (programming)
11	EDID_CLK ²	EDID I ² C clock
12	EDID_DAT ²	EDID I ² C data

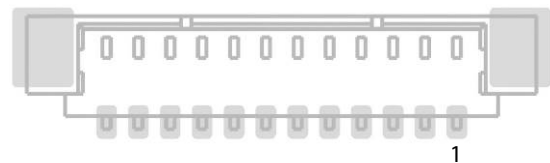

Illustration 11: Backlight Connector, X13

1: A voltage of up to 30 V can be supplied at this pin. Connect Pin 1 and 2 to use the 12 V of the MB-SMARC-1 for the backlight.
 2: These pins can be used to program the on-board EDID EEPROM. The EEPROM can be powered by the 3V3_PROG pin.

3.5.9 MIPI CSI (Camera serial interface), X27, X28

The MB-SMARC-1 is equipped with two connectors where MIPI cameras can be connected.

MIPI CSI connectors X27, X28

- Connector type: Panasonic AXE540127
- Mating connector: Panasonic AXE640124

Table 10: MIPI CSI Connectors, X27, X28

Pin	Signal	Remark
1	GND	–
2	V_1V8_MIPI	1.8 V supply voltage
3	V_1V2_MIPI	1.2 V supply voltage
4	CAM_CLK	Single ended camera clock
5	GND	–
6	RX0–	Lane 0 differential pair
7	RX0+	
8	GND	–
9	CLK–	Clock differential pair
10	CLK+	
11	GND	–
12	RX1–	Lane 1 differential pair
13	RX1+	
14	SID	PU to 3.3 V
15	RX2–	Lane 2 differential pair ³
16	RX2+	
17	V_2V8_MIPI	2.8 V supply voltage
18	NC	–
19	V_3V3	3.3 V supply voltage
20	GND	–
21	GND	–
22	RX3–	Lane 3 differential pair ³
23	RX3+	
24	NC	–
25	NC	–
26	NC	–
27	NC	–
28	NC	–
29	NC	–
30	NC	–
31	XSHUTDOWN#	Shut down (PU to 1.8 V on Carrier)
32	PWDN#	Power down (PU to 1.8 V on Carrier)
33	NC	–
34	NC	–
35	NC	–
36	XSHUTDOWN#	Shut down (PU to 1.8 V on Carrier)
37	I2C_CLK	I ² C Bus for camera support link
38	I2C_DAT	
39	NC	–
40	GND	–

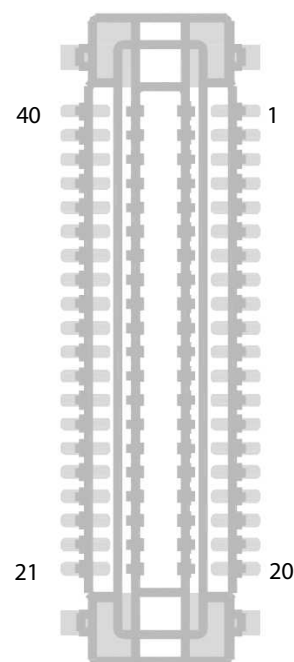

Illustration 12: MIPI CSI Connectors, X27, X28

³: Only available for CSI1.

3.5.10 M.2 Socket with E-Keying (for I/O devices), X43

The MB-SMARC-1 provides a socket to support a M.2 module with 22 mm width and 30 mm length. The signals of a USB and a PCIe ×1 interface are connected to this socket. M.2 2230 single and double sided modules with E or A+E-Keying can be inserted. The maximum transfer rate of this interface mainly depends on the SMARC module used and the connected device.

3.5.11 M.2 Socket with B-Keying (for WWAN devices), X32

The MB-SMARC-1 provides a socket to support a M.2 module with 30 mm width and 42 mm length. The signals of a USB 2.0 interface are connected to this socket. There is also a Micro SIM card socket (X29) for native support of UMTS or LTE M.2 cards. The reachable transfer rate of this interface depends mainly on the SMARC module used and the connected device.

3.5.12 M.2 Socket with B-Keying (for SSD devices), X44

The MB-SMARC-1 provides a socket to support SATA based M.2 SSDs with 22 mm width and 80 mm length. The usage of 2242 M.2 SSDs is also possible. This is an optional feature. M.2 2280 single and double sided modules with B or B+M-Keying can be inserted. The reachable transfer rate of this interface depends mainly on the SMARC module used and the connected device.

3.5.13 M.2 Socket with M-Keying (for SSD devices), X42

The MB-SMARC-1 provides a socket to support PCIe based M.2 SSDs with 22 mm width and 80 mm length. The usage of 2242 M.2 SSDs is also possible. This is an optional feature. M.2 2280 single and double sided modules with M-Keying can be inserted. The transfer rate of this interface mainly depends on the SMARC module used and the connected device.

3.5.14 μSD Card, X30

The MB-SMARC-1 is equipped with a socket to support micro SD cards. The corresponding signals of the SMARC module are connected to the SD card socket.

3.5.15 Audio

The MB-SMARC-1 provides an audio codec and an audio amplifier to support following audio features:

- Headphone out, X3
- Microphone in, X4

3.5.16 Fan Connector, X22

The MB-SMARC-1 provides a connector for 12 V fans with a 3 terminal standard connector.

Table 11: 12 V Fan Connector, X22

Pin	Signal	Remark
1	GND	–
2	Fan Voltage	Output voltage (0 to 12 V PWM)
3	SENSE	Sense input for fan speed (for open drain outputs of fans)

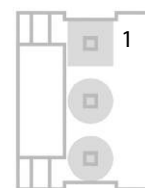

Illustration 13: 12 V Fan Connector, X22

3.5.17 Power and Reset Button Connector, X45

The MB-SMARC-1 provides a connector to connect a power and a reset button.

Power and reset button connector

- Connector type: Molex 53398-0371
- Mating connector: Molex 51021-0300

Table 12: Power and Reset Button Connector, X45

Pin	Signal
1	PWR_BTN#
2	GND
3	RST_BTN#

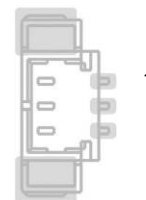

Illustration 14: PWR and RST Button, X45

3.5.18 SPI Flash Socket, X17

The MB-SMARC-1 provides a socket for SPI flashes. This is useful if a BIOS update fails or for BIOS development purposes. SPI-Flashes with SO8W package can be inserted. It depends on the SMARC module used whether a certain flash device is supported. If jumper X16 "BOOT_SEL2_1V8#" is set, the socketed SPI flash BIOS is active.

3.5.19 SMARC Connector, X1

On the MB-SMARC-1 a MXM3 compatible connector is used to contact the gold fingers of the module. The stack height (board to board distance between carrier board and module) is 1.5 mm.

3.5.20 GPIO Header, X38

The MB-SMARC-1 features a 14-pin header with 1.25 mm pitch, Molex part number 53398-1471, which provides 12 GPIOs. A suitable mating connector is e.g., the PicoBlade housing, Molex part number 51021. The following table shows the GPIOs available at GPIO header X38.

Table 13: GPIO Header, X38

Pin	Function
1	GPIO0 / CAM0_PWR#
2	GPIO1 / CAM1_PWR#
3	GPIO2 / CAM0_RST#
4	GPIO3 / CAM1_RST#
5	GPIO4 / HDA_RST#
6	GPIO5 / PWM_OUT
7	GPIO6 / TACHIN
8	GPIO7
9	GPIO8
10	GPIO9
11	GPIO10
12	GPIO11
13	1.8 V
14	GND

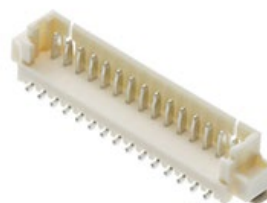

Illustration 15: GPIO header, X38

3.5.21 Power LED, V41

The MB-SMARC-1 provides a power LED. It is visible on the front if an appropriate light pipe is used.

Table 14: Power LED, V41

PCB Text	Function
PWR LED	Off: Carrier is not powered Green: Module is running (in S0 state) Blue: Module is turned off or in sleep state (S5 – soft off or S3/S4 – sleep)

3.5.22 Debug LEDs

The MB-SMARC-1 provides several LEDs for debug purposes.

Table 15: Debug LEDs

Function	PCB Text	Remark
Power	PWR	Green if input power is present
SUS S3	S3 act.	Green if module is in power-saving mode S3 (Suspend to RAM)
SUS S5	S3 act.	Green if module is in power-saving mode S5 (Soft off)
Reset active	RST act.	Green if Reset is asserted
SATA activity	SATA act.	SATA activity LED (green if active)

4. MECHANICS

4.1 Dimensions

The dimensions are according to the Mini-ITX form factor, which is $170 \times 170 \text{ mm}^2$.
The following illustration shows the dimensions of the MB-SMARC-1.

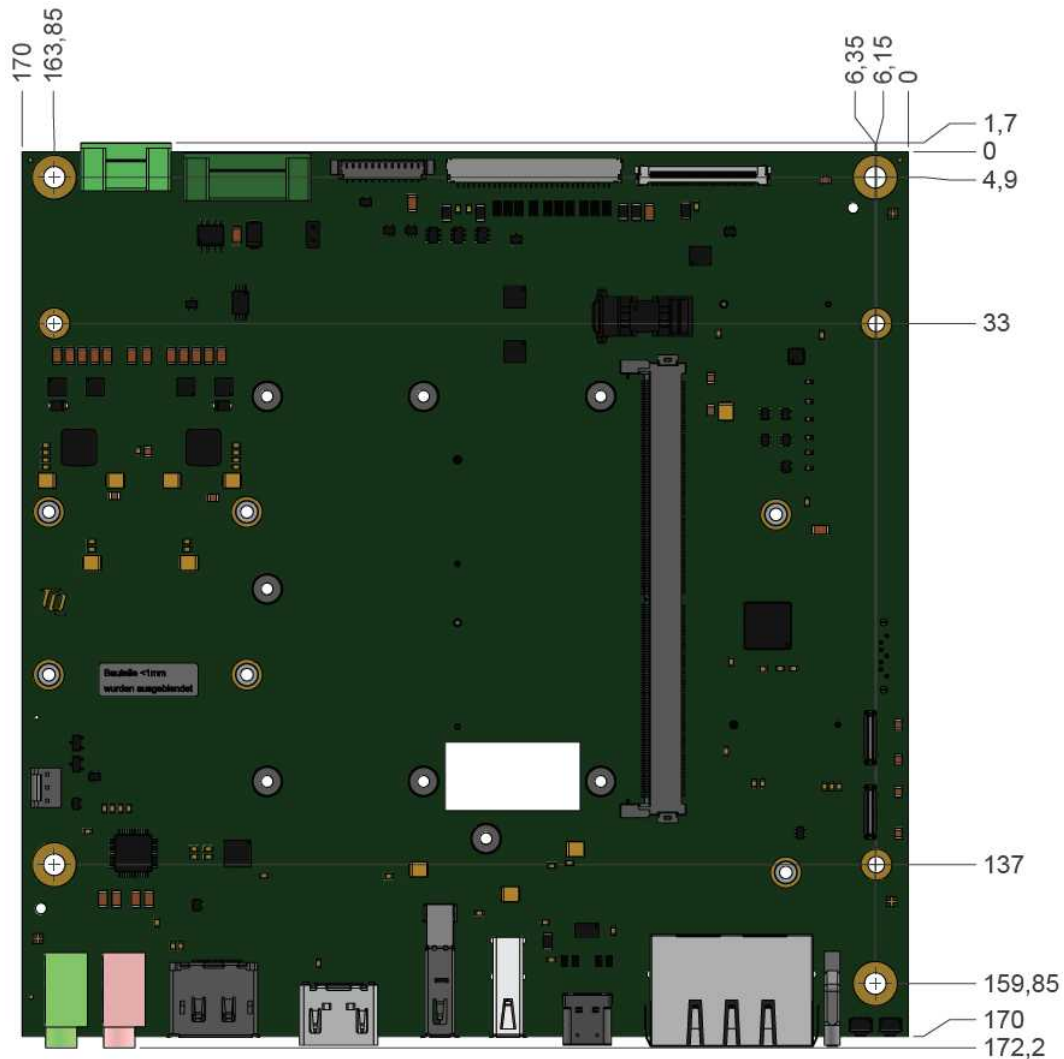

Illustration 16: MB-SMARC-1 dimensions

Please contact [TQ-Support](#) for more details about 2D/3D Step models.

4.2 Protection against External Effects

The MB-SMARC-1 is not protected against dust, external impact and contact (IP00).
Adequate protection has to be guaranteed by the surrounding system.

5. SOFTWARE

5.1 System Resources

5.1.1 General Purpose I²C Bus

The general purpose I²C bus (SMARC pin names I2C_GP_CK and I2C_GP_DAT) is routed to an EEPROM and an I/O expander. It is also accessible on an optional connector.

The following table shows the I²C address mapping for the General Purpose I²C - Bus:

Table 16: I²C Address Mapping General Purpose I²C Bus

8-bit Address	Function	Device	Remark
0xAE	EEPROM	AT24C32E	EEPROM for software test purposes
0xE0	I/O Expander	PCA9538ABS	I/O Expander for software test purposes

5.1.2 SMBus / Power Management I²C Bus

The SMBus (System Management Bus) (SMARC pin names I2C_PM_CK and I2C_PM_DAT) is accessible on an optional connector. There are no devices connected to this bus on the MB-SMARC-1.

5.2 Operating Systems

5.2.1 Supported Operating Systems

The MB-SMARC-1 supports various Operating Systems:

- Microsoft® Windows® 10
- Microsoft® Windows® 8.1 / Microsoft® Windows® Embedded Standard 8 (WES8)
- Microsoft® Windows® 7 / Microsoft® Windows® Embedded Standard 7 (WES7)
- Linux (i.e. Ubuntu 14.10 or later)

Other Operating Systems are supported on request.

Please contact [TQ-Support](#) for further information about supported Operating Systems.

5.2.2 Driver Download

The MB-SMARC-1 module is well supported by the Standard Operating Systems, which already include most of the drivers required. It is recommended to use the latest drivers for optimal performance and the full feature set of the module.

Drivers for the Intel® i201IT Gigabit Ethernet controller can be downloaded at this Intel® page:

- Intel® Download Center: Intel® Ethernet Controller i210 Series
<https://downloadcenter.intel.com/product/64399/Intel-Ethernet-Controller-I210-Series>

Please contact [TQ-Support](#) for further driver download assistance.

6. SAFETY REQUIREMENTS AND PROTECTIVE REGULATIONS

6.1 EMC

The MB-SMARC-1 was developed according to the requirements of electromagnetic compatibility (EMC). Depending on the target system, anti-interference measures may still be necessary to guarantee that the limits for the overall system including housing are met.

6.2 ESD

In order to avoid interspersions on the signal path from the input to the protection circuit in the system, the protection against electrostatic discharge should be arranged directly at the inputs of a system. Most external interfaces are protected using ESD protection diodes. Measurements for ESD protection have to be done with the electronic parts mounted in a housing. Since TQ-Systems GmbH does not offer a housing for the MB-SMARC-1, no special preventive measures are taken.

6.3 Operational Safety and Personal Security

Due to the occurring voltages (12 V DC), tests with respect to the operational and personal safety have not been carried out.

6.4 Reliability and Service Life

The MTBF according to MIL-HDBK-217F N2 is 523,870 hours, Ground Benign, @ +40 °C.

6.5 Environment protection

6.5.1 RoHS

The MB-SMARC-1 is manufactured RoHS compliant.

- All components and assemblies are RoHS compliant
- The soldering processes are RoHS compliant

6.5.2 WEEE®

The final distributor is responsible for compliance with the WEEE® regulation.

Within the scope of the technical possibilities, the MB-SMARC-1 was designed to be recyclable and easy to repair.

6.5.3 REACH®

The EU-chemical regulation 1907/2006 (REACH® regulation) stands for registration, evaluation, certification and restriction of substances SVHC (Substances of very high concern, e.g., carcinogen, mutagen and/or persistent, bio accumulative and toxic). Within the scope of this juridical liability, TQ-Systems GmbH meets the information duty within the supply chain with regard to the SVHC substances, insofar as suppliers inform TQ-Systems GmbH accordingly.

6.5.4 EuP

The Ecodesign Directive, also Energy using Products (EuP), is applicable to products for the end user with an annual quantity >200,000. The MB-SMARC-1 must therefore always be seen in conjunction with the complete device.

The available standby and sleep modes of the components on the MB-SMARC-1 enable compliance with EuP requirements for the MB-SMARC-1.

6.5.5 Packaging

By environmentally friendly processes, production equipment and products, we contribute to the protection of our environment. To be able to reuse the MB-SMARC-1, it is produced in such a way (a modular construction) that it can be easily repaired and disassembled. The energy consumption of this subassembly is minimised by suitable measures. The MB-SMARC-1 is delivered in reusable packaging.

6.6 Battery

6.6.1 General notes

Due to technical reasons a battery is necessary for the MB-SMARC-1. Batteries containing mercury (Hg), cadmium (Cd) or lead (Pb) are not used. If this is for technical reasons unavoidable, the device is marked with the corresponding hazard note. To allow a separate disposal, batteries are generally only mounted in sockets.

6.6.2 Lithium batteries

The requirements concerning special provision 188 of the ADR (section 3.3) are complied with for Lithium batteries. There is therefore no classification as dangerous goods:

- Basic lithium content per cell not more than 1 grams (except for lithium ion and lithium polymer cells for which a lithium content of not more than 1.5 g per cell applies (equals 5 Ah)).
- Basic lithium content per battery not more than 2grams (except for lithium ion batteries for which a lithium content of not more than 8 grams per cell applies (equals 26 Ah)).
- Lithium cells and batteries are examined according to UN document ST/SG/AC.10-1.

During transport a short circuit or discharging of the socketed lithium battery is prevented by extricable insulating foils or by other suitable insulating measures.

6.7 Other Entries

By environmentally friendly processes, production equipment and products, we contribute to the protection of our environment. To be able to reuse the MB-SMARC-1, it is produced in such a way, that it can be easily repaired and disassembled. The energy consumption of this subassembly is minimised by suitable measures. Due to the fact that at the moment there is still no technical equivalent alternative for printed circuit boards with bromine-containing flame protection (FR-4 material), such printed circuit boards are still used. No use of PCB containing capacitors and transformers (polychlorinated biphenyls). These points are an essential part of the following laws:

- The law to encourage the circular flow economy and assurance of the environmentally acceptable removal of waste as at 27.9.94 (Source of information: BGBl I 1994, 2705)
- Regulation with respect to the utilization and proof of removal as at 1.9.96 (Source of information: BGBl I 1996, 1382, (1997, 2860))
- Regulation with respect to the avoidance and utilization of packaging waste as at 21.8.98 (Source of information: BGBl I 1998, 2379)
- Regulation with respect to the European Waste Directory as at 1.12.01 (Source of information: BGBl I 2001, 3379)

This information is to be seen as notes. Tests or certifications were not carried out in this respect.

7. APPENDIX

7.1 Acronyms and Definitions

The following acronyms and abbreviations are used in this document.

Table 17: Acronyms

Acronym	Meaning
ATA	Advanced Technology Attachment
BIOS	Basic Input/Output System
CAN	Controller Area Network
CSI	Camera Serial Interface (MIPI)
DIP	Dual In-line Package
DP	Display Port
DVI	Digital Visual Interface
EDID	Extended Display Identification Data
eDP	embedded Display Port
EEPROM	Electrically Erasable Programmable Read-Only Memory
EMC	Electromagnetic Compatibility
ESD	Electrostatic Discharge
EuP	Energy using Products
FAE	Field Application Engineer
flexiCFG	Flexible Configuration
FR-4	Flame Retardant 4
FTDI	Future Technology Devices International
GPIO	General-Purpose Input/Output
HD	High Definition (Audio)
HDA	High-Definition Audio (Intel)
HDMI	High Definition Multimedia Interface
HPD	Hot Plug Detect
I/O	Input/Output
I2C	Inter-Integrated Circuit
I2S	Integrated Interchip Sound
IEEE®	Institute of Electrical and Electronics Engineers
IP	Ingress Protection
LCD	Liquid Crystal Display
LED	Light Emitting Diode
LTE	Long Term Evolution
LVDS	Low Voltage Differential Signal
MIPI	Mobile Industry Processor Interface
mPCIe	Mini Peripheral Component Interconnect Express
MTBF	Mean (operating) Time Between Failures
NC	Not Connected
OTG	On-The-Go

7.1 Acronyms and Definitions (continued)

Table 17: Acronyms (continued)

Acronym	Meaning
PC	Personal Computer
PCB	Printed Circuit Board
PCI	Peripheral Component Interconnect
PCIe	Peripheral Component Interconnect express
PCMCIA	People Can't Memorize Computer Industry Acronyms
PICMG®	PCI Industrial Computer Manufacturers Group
PWM	Pulse-Width Modulation
PWR	Power
RAM	Random Access Memory
REACH®	Registration, Evaluation, Authorisation (and restriction of) Chemicals
RJ45	Registered Jack 45
RMA	Return Merchandise Authorization
RoHS	Restriction of (the use of certain) Hazardous Substances
RS-232	Recommended Standard (serial interface)
SATA	Serial ATA
SD	Secure Digital
SGET	Standardization Group for Embedded Technologies
SIM	Subscriber Identity Module
SM	System Management
SMARC	Smart Mobile ARChitecture
SMB	System Management Bus
SPI	Serial Peripheral Interface
SSD	Solid-State Drive
SVHC	Substances of Very High Concern
UEFI	Unified Extensible Firmware Interface
UMTS	Universal Mobile Telecommunications System
UN	United Nations
USB	Universal Serial Bus
VGA	Video Graphics Array (640 × 480)
WEEE®	Waste Electrical and Electronic Equipment
WES	(Microsoft®) Windows® Embedded Standard
WLAN	Wireless Local Area Network
WWAN	Wireless Wide Area Network



7.2 References

Table 18: Further Applicable Documents and Links

No.	Name	Rev. / Date	Company
(1)	SGET SMARC Hardware Specification (and Errata) https://www.sget.org/fileadmin/user_upload/SMARC_Hardware_Specification_V200_Errata.zip	V2.0 / June 2016 V2_errata1.1/Feb 2017	SGET
(2)	SGET SMARC Design Guide (available for public download) https://www.sget.org/fileadmin/user_upload/SMARC_DG_V2.pdf	V2.0 / June 2016	SGET
(3)	Intel® Download Center: Intel® Ethernet Controller i210 Series https://downloadcenter.intel.com/product/64399/Intel-Ethernet-Controller-I210-Series		Intel

