



MB-COME6-4 User's Manual

MB-COME6-4 UM 0100
15.03.2022

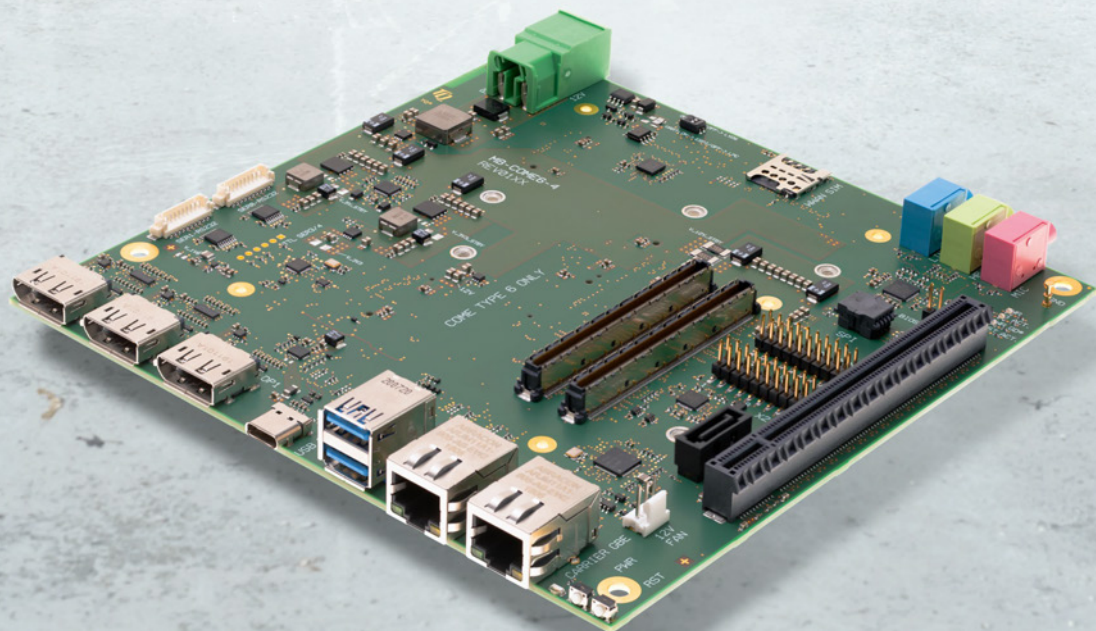



TABLE OF CONTENTS

1.	ABOUT THIS MANUAL	1
1.1	Copyright and Licence Expenses	1
1.2	Registered Trademarks	1
1.3	Disclaimer	1
1.4	Imprint	1
1.5	Service and Support	1
1.6	Tips on Safety	2
1.7	Symbols and Typographic Conventions	2
1.8	Handling and ESD Tips	2
1.9	Naming of Signals	3
1.10	Further Applicable Documents / Presumed Knowledge	3
2.	INTRODUCTION	4
2.1	Functional Overview	4
2.2	Specification Compliance	5
2.3	Carrier Board Standard Configurations	5
2.4	Accessories	5
3.	FUNCTION	6
3.1	Block Diagram	6
3.2	Electrical Specification	7
3.2.1	Supply Voltage Characteristics	7
3.2.2	Power Consumption Specification	7
3.3	Environmental Specification	7
3.4	System Components	7
3.4.1	Gigabit Ethernet Controller	7
3.4.2	HD-Audio Controller	7
3.5	Connectors and Interfaces	8
3.5.1	Power Supply	10
3.5.2	DisplayPort	10
3.5.3	USB Host Interfaces	11
3.5.4	Gigabit Ethernet	11
3.5.5	Serial Interface (RS-232)	12
3.5.6	Embedded Display Port	13
3.5.7	LVDS	14
3.5.8	M.2 socket with M Key (for PCIe SSD devices)	15
3.5.9	M.2 socket with M Key (for PCIe SSD devices)	15
3.5.10	M.2 socket with B Key (for WWAN modules or SATA SSD devices)	15
3.5.11	M.2 socket with E Key (for I/O devices)	15
3.5.12	SATA Interfaces	16
3.5.13	Audio	16
3.5.14	Fan Connector	16
3.5.15	PCI Express Connector	16
3.5.16	Feature Connector	17
3.5.17	Debug LEDs	18
3.5.18	SPI Flash Socket	18
3.5.19	COM Express™ Connector	18
3.6	Buttons	18
3.6.1	Reset Button	18
3.6.2	Power Button	18
4.	MECHANICS	19
4.1	Dimensions	19
4.2	Protection Against External Effects	19
4.3	Labeling	20
5.	SOFTWARE	21
5.1	System Resources	21
5.1.1	I ² C Bus	21
5.1.2	SMBus	21
5.2	Driver Download	21
6.	SAFETY REQUIREMENTS AND PROTECTIVE REGULATIONS	22
6.1	EMC	22
6.2	ESD	22
6.3	Operational Safety and Personal Security	22
6.4	Reliability and Service Life	22
6.4.1	RoHS	22



6.5	WEEE®	22
6.6	REACH®	22
6.7	EuP	22
6.8	Battery	22
6.9	Packaging	22
6.10	Other Entries	23
7.	APPENDIX	24
7.1	Acronyms and Definitions	24
7.2	References	26

TABLE DIRECTORY

Table 1:	Terms and Conventions	2
Table 2:	Power-In Connector	10
Table 3:	USB 2.0 Host Extension Connectors	11
Table 4:	Ethernet LEDs	11
Table 5:	Serial Port COM Express™ Port Mapping	12
Table 6:	Serial Port RS-232 pinout via cable to 9-pin D-Sub	12
Table 7:	eDP Connector	13
Table 8:	LVDS Connector	14
Table 9:	Backlight Connector	15
Table 10:	Fan Connector	16
Table 11:	GPIO and COME Signal Connector X20	17
Table 12:	I ² C and COME Signal Connector X21	17
Table 13:	Debug LEDs	18
Table 14:	Labels on MB-COME6-4	20
Table 15:	I ² C Address Mapping	21
Table 16:	Acronyms	24
Table 17:	Further Applicable Documents and Links	26

FIGURE DIRECTORY

Figure 1:	MB-COME6-4 Block Diagram	6
Figure 2:	MB-COME6-4 Top view	8
Figure 3:	MB-COME6-4 Bottom view	9
Figure 4:	RJ45 Connectors	11
Figure 5:	10-pin RS232 Connector	12
Figure 6:	eDP Connector	13
Figure 7:	Config Switch: eDP / LVDS	13
Figure 8:	LVDS Connector	14
Figure 9:	Backlight Connector	15
Figure 10:	Audio Connectors X12, X13, X14	16
Figure 11:	Fan Connector	16
Figure 12:	Feature Connectors	17
Figure 13:	SPI socket and BIOS_DIS1# Jumper	18
Figure 14:	MB-COME6-4 Dimensions	19
Figure 15:	Position of labels	20

REVISION HISTORY

Rev.	Date	Name	Pos.	Modification
0100	15.03.2022	Probst		First edition



1. ABOUT THIS MANUAL

1.1 Copyright and Licence Expenses

Copyright protected © 2022 by TQ-Systems GmbH.

This User's Manual may not be copied, reproduced, translated, changed or distributed, completely or partially in electronic, machine readable, or in any other form without the written consent of TQ-Systems GmbH.

The drivers and utilities for the components used as well as the BIOS are subject to the copyrights of the respective manufacturers. The licence conditions of the respective manufacturer are to be adhered to.

BIOS-licence expenses are paid by TQ-Systems GmbH and are included in the price.

Licence expenses for the operating system and applications are not taken into consideration and must be calculated / declared separately.

1.2 Registered Trademarks

TQ-Systems GmbH aims to adhere to copyrights of all graphics and texts used in all publications, and strives to use original or license-free graphics and texts.

All brand names and trademarks mentioned in this User's Manual, including those protected by a third party, unless specified otherwise in writing, are subjected to the specifications of the current copyright laws and the proprietary laws of the present registered proprietor without any limitation. One should conclude that brand and trademarks are rightly protected by a third party.

1.3 Disclaimer

TQ-Systems GmbH does not guarantee that the information in this User's Manual is up-to-date, correct, complete or of good quality. Nor does TQ-Systems GmbH assume guarantee for further usage of the information. Liability claims against TQ-Systems GmbH, referring to material or non-material related damages caused, due to usage or non-usage of the information given in this User's Manual, or due to usage of erroneous or incomplete information, are exempted, as long as there is no proven intentional or negligent fault of TQ-Systems GmbH.

TQ-Systems GmbH explicitly reserves the rights to change or add to the contents of this User's Manual or parts of it without special notification.

1.4 Imprint

TQ-Systems GmbH
Gut Delling, Mühlstraße 2
D-82229 Seefeld

Tel: +49 8153 9308-0

Fax: +49 8153 9308-4223

E-Mail: Info@TQ-Group

Web: TQ-Group

1.5 Service and Support

Please visit our website www.tq-group.com for latest product documentation, drivers, utilities and technical support.

You can register on our website www.tq-group.com to have access to restricted information and automatic update services.

For direct technical support you can contact our FAE team by email: support@tq-group.com.

Our FAE team can also support you with additional information like 3D-STEP files and confidential information, which is not provided on our public website.





For service/RMA, please contact our service team by email (service@tq-group.com) or your sales team at TQ.

1.6 Tips on Safety

Improper or incorrect handling of the product can substantially reduce its life span.

1.7 Symbols and Typographic Conventions

Table 1: Terms and Conventions

Symbol	Meaning
	This symbol represents the handling of electrostatic-sensitive modules and / or components. These components are often damaged / destroyed by the transmission of a voltage higher than about 50 V. A human body usually only experiences electrostatic discharges above approximately 3,000 V.
	This symbol indicates the possible use of voltages higher than 24 V. Please note the relevant statutory regulations in this regard. Non-compliance with these regulations can lead to serious damage to your health and also cause damage / destruction of the component.
	This symbol indicates a possible source of danger. Acting against the procedure described can lead to possible damage to your health and / or cause damage / destruction of the material used.
	This symbol represents important details or aspects for working with TQ-products.
Command	A font with fixed width denotes commands, contents, file names, or menu items.

1.8 Handling and ESD Tips

General handling of your TQ-products

	<p>The TQ-product may only be used and serviced by certified personnel who have taken note of the information, the safety regulations in this document and all related rules and regulations.</p> <p>A general rule is: do not touch the TQ-product during operation. This is especially important when switching on, changing jumper settings or connecting other devices without ensuring beforehand that the power supply of the system has been switched off.</p> <p>Violation of this guideline may result in damage / destruction of the MB-COME6-4 module and be dangerous to your health.</p> <p>Improper handling of your TQ-product would render the guarantee invalid.</p>
---	---

Proper ESD handling

	<p>The electronic components of your TQ-product are sensitive to electrostatic discharge (ESD).</p> <p>Always wear antistatic clothing, use ESD-safe tools, packing materials etc., and operate your TQ-product in an ESD-safe environment. Especially when you switch modules on, change jumper settings, or connect other devices.</p>
---	--



1.9 Naming of Signals

A hash mark (#) at the end of the signal name indicates a low-active signal.

Example: RESET#

If a signal can switch between two functions and if this is noted in the name of the signal, the low-active function is marked with a hash mark and shown at the end.

Example: C / D#

If a signal has multiple functions, the individual functions are separated by slashes when they are important for the wiring. The identification of the individual functions follows the above conventions.

Example: WE2# / OE#

1.10 Further Applicable Documents / Presumed Knowledge

- **Specifications and manual of the modules used:**
These documents describe the service, functionality and special characteristics of the module used.
- **Specifications of the components used:**
The manufacturer's specifications of the components used, for example CompactFlash cards, are to be taken note of. They contain, if applicable, additional information that must be taken note of for safe and reliable operation. These documents are stored at TQ-Systems GmbH.
- **Chip errata:**
It is the user's responsibility to make sure all errata published by the manufacturer of each component are taken note of. The manufacturer's advice should be followed.
- **Software behaviour:**
No warranty can be given, nor responsibility taken for any unexpected software behaviour due to deficient components.
- **General expertise:**
Expertise in electrical engineering / computer engineering is required for the installation and the use of the device.

Implementation information for the carrier board design is provided in the COM Express™ Design Guide (2) maintained by the PICMG®. This Carrier Design Guide includes a very good guideline to design a COM Express™ carrier board.

It includes detailed information with schematics and detailed layout guidelines.

Please refer to the official PICMG® documentation for additional information (1), (2).



2. INTRODUCTION

The COM Express™ mainboard MB-COME6-4 is a carrier board for COM Express™ modules with Type 6 pinout. It can be used for panel PCs, embedded computers or as an evaluation platform for COM Express™ modules. In combination with a standard COM Express™ module it forms a very compact hardware kit that can be used for a freely scalable embedded PC platform. Because of this – with uniform interfaces and dimensions – the PC system can be easily adapted to suit the requirements of the application. The wide range of extension options and storage media, which can be added, offer a high level of flexibility and allow functionalities and performance to be extended easily, quickly and inexpensively. Typical usage is in embedded server applications, PC systems for automation, visualisation and monitoring and all applications that place high demands on quality, durability and long-term availability.

2.1 Functional Overview

The following key functions are implemented on the MB-COME6-4:

Supported Modules:

- COM Express™ Compact / Basic Modules with Type 6 pinout (COM.0 R3.0)

External Interfaces:

- 2 x 2.5 Gigabit Ethernet
- 2 x USB 3.2 Gen 2 Type A connector with USB 3.0 compatibility
- 1 x USB 3.2 Gen 2 Type C connector with USB 3.0 compatibility
- 3 x DisplayPort (DP++) connectors
- 3 x Audio (headphone out, microphone in and line in)
- Power Button / Reset

Internal Interfaces:

- 1 x LVDS and eDP connector
- 1 x Backlight power connector
- 3 x USB 2.0 on board header
- 1 x M.2 socket with B Key USB 2.0 and SATA (with micro SIM Card support e.g. for WWAN/LTE or SATA SSDs)
- 1 x M.2 socket with E Key USB 2.0 and PCIe x1 (for WLAN / Bluetooth cards)
- 1 x M.2 socket with M Key PCIe x4 (for SSDs)
- 1 x M.2 socket with M Key PCIe x2 (for SSDs)
- 1 x SATA connector
- 2 x Serial ports with RS-232 transceivers
- 1 x PEG Port to support standard PCIe add in cards with up to 16 lanes
- 2 x GPIO / I²C / MISC connectors

Power supply:

- Voltage: 12 V DC ±5 %

Environment:

- Extended temperature: –20 °C to +85 °C

Form factor / dimensions:

- 170 mm × 170 mm (Mini ITX)

2.2 Specification Compliance

The MB-COME6-4 supports Compact or Basic modules compliant to the PICMG® COM Express™ Module Base Specification (COM.0 R3.0) with Type 6 pinout.

2.3 Carrier Board Standard Configurations

- **MB-COME6-4-AA**
COM Express™ Type 6 pinout Carrier full-featured

Other configurations are available on request.

2.4 Accessories

- **DK-USB-TYPA-MOL5**
Adapter cable from internal USB connector to A-Type receptacle, 150 mm long
- **DK-RS232-9POL-DSUB-PICOBLADE**
Adapter cable from internal connector to 9-pin D-Sub male connector, 150 mm long
- **Battery CR2032 lithium coin cell**
- **Meanwell 180W 12V Power Supply GST220A12-R7B**



Please contact support@tq-group.com for details about Display Port cables and Display Port to DVI/HDMI adapters.

3. FUNCTION

3.1 Block Diagram

The following illustration shows the block diagram of the MB-COME6-4:

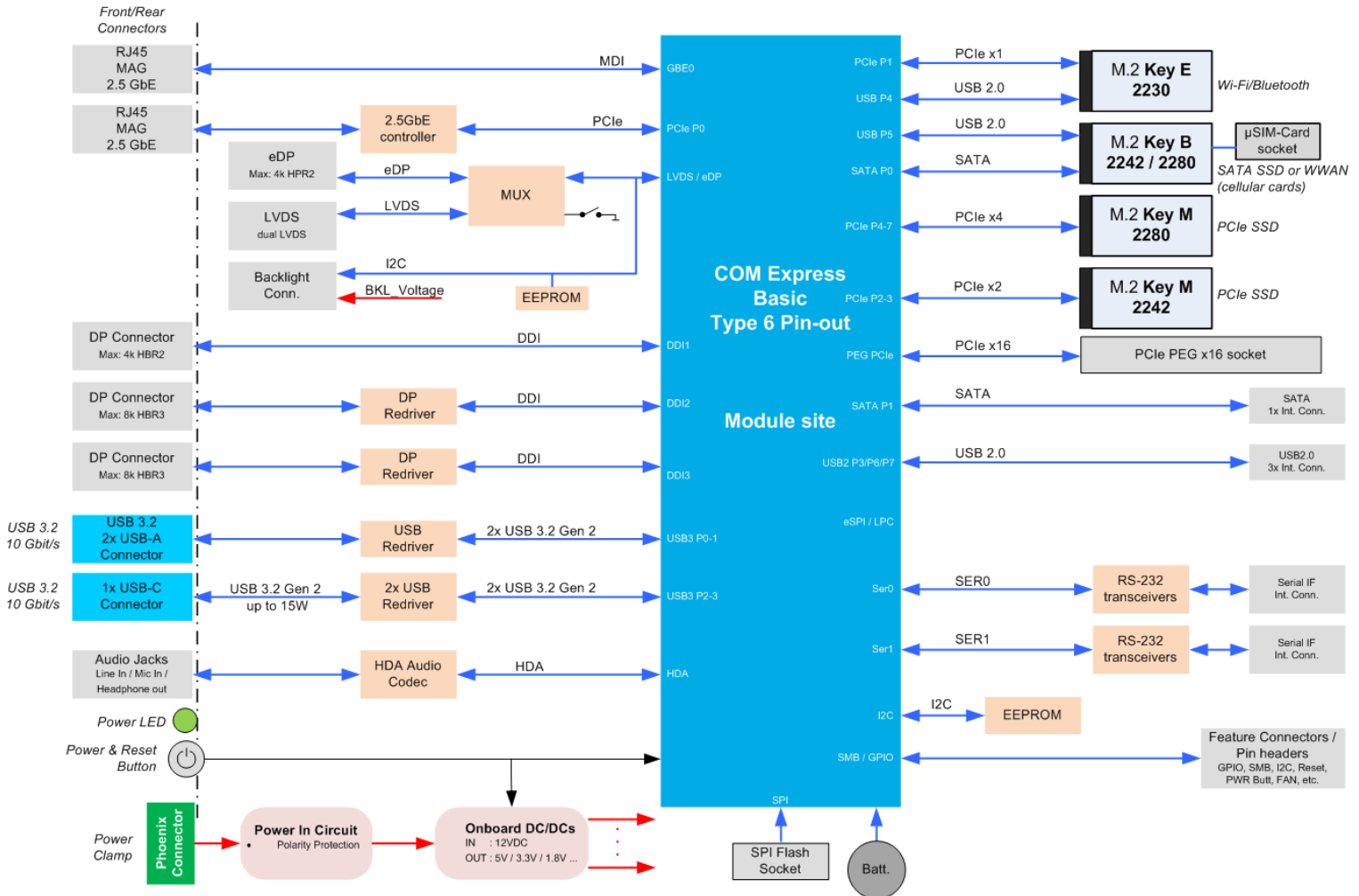

Figure 1: MB-COME6-4 Block Diagram

3.2 Electrical Specification

3.2.1 Supply Voltage Characteristics

The MB-COME6-4 requires an input voltage of 12 V DC $\pm 5\%$.

The input voltages shall rise from 10 % of nominal to 90 % of nominal within 0.1 ms to 20 ms ($0.1 \text{ ms} \leq \text{Rise Time} \leq 20 \text{ ms}$).

There must be a smooth and continuous increase of each DC output voltage from 10 % to 90 % of its final set point within the regulation range.

3.2.2 Power Consumption Specification

The power consumption of the system significantly depends on the connected devices; e.g. COM Express™ module, mass storage devices, USB devices, display backlight, etc.

The power consumption of the MB-COME6-4 itself is approximately 2 W (COM Express™ module supplied externally);
UEFI-shell active; no keyboard, no mouse, no mass storage device, no Ethernet cable etc. connected).

Note: Power requirement



The MB-COME6-4 input current is not fused. The user has to ensure that the input current does not exceed the **maximum current of 25 A (300 W)**.

Additionally the power supply must be configured with enough reserve. It should be calculated with the maximum power consumption of all connected components.

3.3 Environmental Specification

- Operating temperature, extended: -20 °C to $+85\text{ °C}$
- Storage temperature: -40 °C to $+85\text{ °C}$
- Relative humidity (operating / storage): 10 % to 90 % (not condensing)

3.4 System Components

3.4.1 Gigabit Ethernet Controller

The MB-COME6-4 provides an Intel® i225IT Ethernet controller with 10/100/1000/2500 Mbps speed (802.3 specification) and IEEE1588 support.

Please contact support@tq-group.com for further information about the IEEE1588 support.

3.4.2 HD-Audio Controller

The MB-COME6-4 provides a Cirrus Logic CS4207 High Definition Audio Codec with a headphone output a line in input a microphone input.

3.5 Connectors and Interfaces

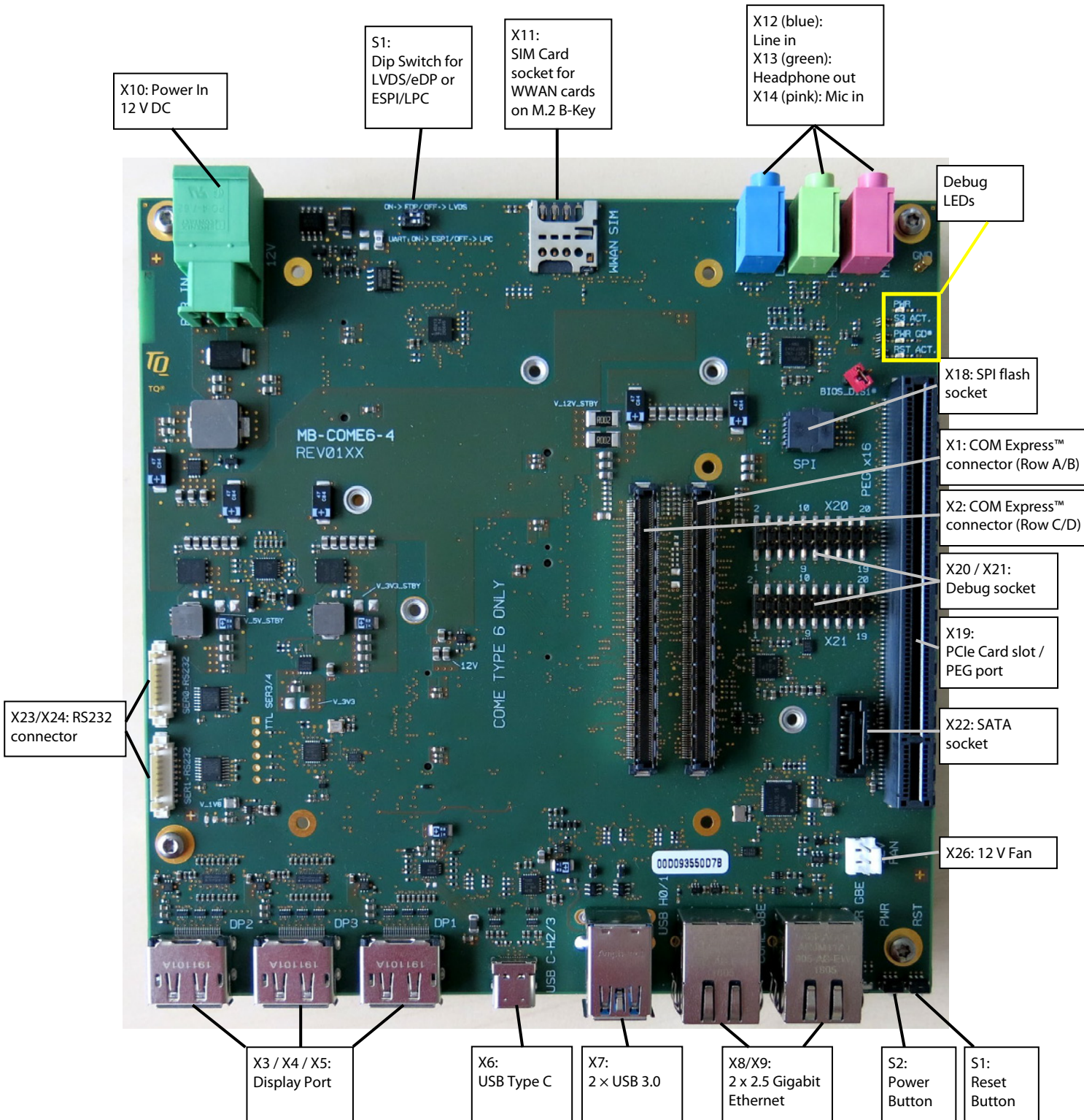

Figure 2: MB-COME6-4 Top view

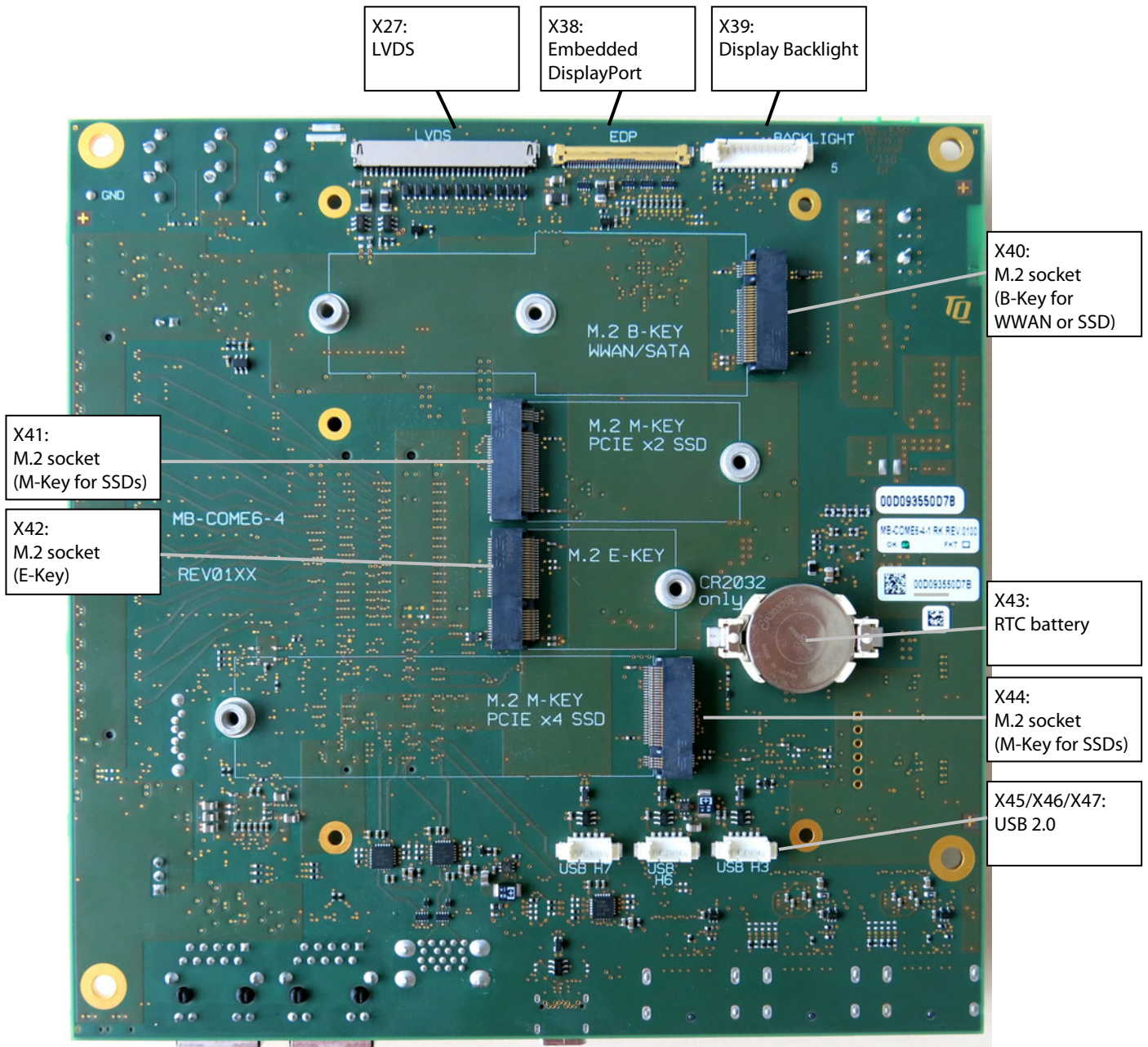

Figure 3: MB-COME6-4 Bottom view

3.5.1 Power Supply

The MB-COME6-4 requires a single 12 V DC power supply. The supply voltage should not vary more than $\pm 5\%$.

X10: Power-In Connector

- Connector type: Phoenix PC4/2-G-7,62
- Mating connector: Phoenix PC4/2-ST-7,62 (up to 20 A)
Phoenix PC5/2-ST-7,62 (up to 25 A)

Table 2: Power-In Connector

Pin	Signal	Remark
1	12 V	max. 25 A, current limit has to be supported from power supply
2	GND	–

Note: Power requirement



The MB-COME6-4 input current is not fused. The user has to ensure that the input current does not exceed the **maximum current of 25 A (300 W)**.

Additionally the cable diameter has to be selected in correlation to the maximum current.

The mainboard power design is optimized for the new high performance TQMx110EB COM Express™ module. This module can draw up to 200 W power for 10 seconds at power up.

3.5.2 DisplayPort

The MB-COME6-4 supports three DisplayPort interfaces.

Reference	Naming	Possible Resolution and Datarate
X3	DP2	8k (HBR3)
X4	DP3	8k (HBR3)
X5	DP1	4k (HBR2)

3.5.3 USB Host Interfaces

The MB-COME6-4 supports several USB Host interfaces.

- X7: USB 3.2 Gen 2 (up to 10 Gb/s) double Type A connector with USB 3.0 compatibility
Power: up to 1.5 A @ 5 V
- X6: USB 3.2 Gen 2 (up to 10 Gb/s) Type C connector with USB 3.0 compatibility
Power: up to 3 A @ 5 V
- X45 / X46 / X47: USB 2.0 host extension connector for usage of a USB 2.0 host port with an adapter cable
- Connector type: Molex 53398-0571
 - Mating connector: Molex 51021-0500 crimp housing

Table 3: USB 2.0 Host Extension Connectors

Pin	Signal	Cable Colour
1	+5 V	Red
2	D-	White
3	D+	Green
4	GND	Black
5	GND	–

3.5.4 Gigabit Ethernet

The MB-COME6-4 supports two 2.5 Gigabit Ethernet ports.

The Ethernet signals of the COM Express™ connector are routed to the X8 (left) connector.

The MB-COME6-4 provides an Intel® i225 Ethernet controller with 10/100/1000/2500 Mbps speed, connected to the X9 (right) connector.

Table 4: Ethernet LEDs

LED	Status
Left, green (Link)	Off: No link
	Shines: Link established
Right, yellow (ACT)	Off: No activity
	Shines: Activity

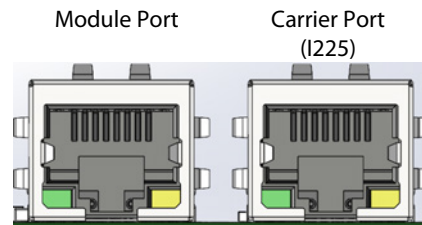

Figure 4: RJ45 Connectors

3.5.5 Serial Interface (RS-232)

The MB-COME6-4 supports two RS232 serial ports at the on board connector

- Connector type: Molex 53398-1071
- Mating connector: Molex 51021-1000 crimp housing

The COM Express™ Specification does only provide signal definitions for RX and TX lines for the serial interface. Due to the TQ-flexiCFG feature, the serial ports can be configured to route the handshake signals to free pins on the COM Express connector.

Table 5: Serial Port COM Express™ Port Mapping

COM Express Signal	COM Express Pin	MB-COME6-4	Remark
SER0_TX	A98	SER0_TX	3.3 V input
SER0_RX	A99	SER0_RX	3.3 V output
SER1_TX	A101	SER1_TX	3.3 V input (not available)
SER1_RX	A102	SER1_RX	3.3 V output (not available)
SER0_RTS# ¹	B98	SER0_RTS#	3.3 V input
SER0_CTS# ¹	B99	SER0_CTS#	3.3 V output
SER1_RTS# ¹	D24	SER1_RTS#	3.3 V input (not available)
SER1_CTS# ¹	D25	SER1_CTS#	3.3 V output (not available)

The four COM Express™ serial signals (RX/TX) are specified to provide a protection and level shifter circuit.

The implementation of this circuit would result in a lower transfer speed on the two serial ports of the COM Express™ module.

On the MB-COME6-4 the protection circuit is removed and the serial ports provide a transfer rate of up to 115 kbaud.

The MB-COME6-4 can only be used in combination with Type 6 pinout COM Express™ modules.

Table 6: Serial Port RS-232 pinout via cable to 9-pin D-Sub

Pin	RS-232 Signal (all signals)	MB-COME6-4	D-Sub connector (with DSUB-Adaptor)
1	DCD	NC ²	–
2	DSR	NC ²	RXD
3	RXD	RXD	TXD
4	RTS	RTS ³	–
5	TXD	TXD ³	GND
6	CTS	CTS	–
7	DTR	NC ²	RTS
8	RI	NC ²	CTS
9	GND	GND	–
10	–	NC	–

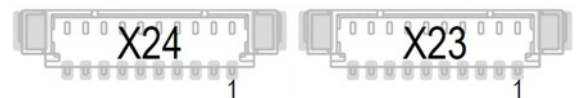

Figure 5: 10-pin RS232 Connector

1: These signals are not specified in COM Express™ specification.

These signals are only available when the TQ flexiCFG feature is available on the COM Express™ module. TQ modules support this feature.

2: Not available since signal is not defined in COM Express™ specification.

3: Only available when the TQ flexiCFG feature is available on the COM Express™ module.

3.5.6 Embedded Display Port

The MB-COME6-4 provides an embedded DisplayPort (eDP) where suitable displays can be directly connected. To select the eDP interface on the MB-COME6-4 the DIP switch on the carrier has to be set to the "eDP" position. This functionality is only available if the COM Express™ module provides the eDP interface.

Please contact support@tq-group.com for further information about eDP or LVDS support.

X38: eDP connector
 – Connector type: JAE HD1S040HA1
 – Mating connector: JAE HD1P040MA1

Table 7: eDP Connector

Pin	Signal	Remark
1	NC	–
2	GND	–
3	TX3–	Lane 3 differential pair
4	TX3+	
5	GND	–
6	TX2–	Lane 2 differential pair
7	TX2+	
8	GND	–
9	TX1–	Lane 1 differential pair
10	TX1+	
11	GND	–
12	TX0–	Lane 0 differential pair
13	TX0+	
14	GND	–
15	AUX+	AUX - channel
16	AUX–	
17	GND	–
18	3V3	3.3 V supply voltage
19	3V3	
20	3V3	
21	3V3	
22	NC	–
23	GND	–
24	GND	
25	GND	
26	GND	
27	HPD	Hot Plug Detect
28	GND	–
29	GND	
30	GND	
31	GND	
32	BLKT_EN	Backlight enable
33	BLKT_CTRL	Backlight (brightness) control
34	VDD_EN	Panel power enable
35	AUX_SEL	Low ⇒ AUX; High ⇒ I ² C
36	V_BLKT	12 V Backlight supply voltage
37	V_BLKT	
38	V_BLKT	
39	V_BLKT	
40	NC	–

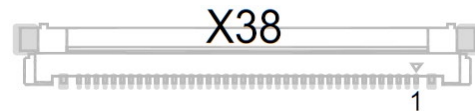

Figure 6: eDP Connector

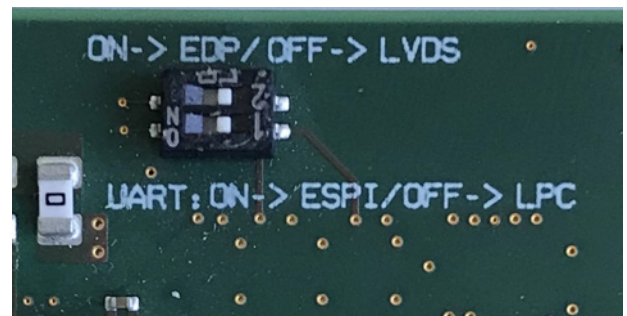

Figure 7: Config Switch: eDP / LVDS

3.5.7 LVDS

The MB-COME6-4 provides a LVDS interface where suitable displays can be directly connected. To select the LVDS interface on the MB-COME6-4 the DIP switch on the carrier has to be set to the "LVDS" position. This functionality is only available if the COM Express™ module provides the LVDS interface.

There are also connectors to power the backlight of the connected display.

The MB-COME6-4 has an on board EDID EEPROM to store display specific timing information. The EEPROM can be programmed with an external I²C programmer. If the programmer supports 3.3 V output voltage, the MB-COME6-4 can be programmed without any additional power supply. In this case no COM Express™ module should be connected to the carrier board.

X27: LVDS connector
 – Connector type: Hirose DF19G-30P-1H
 – Mating connector: Hirose DF19-30S-1C

Table 8: LVDS Connector

Pin	Signal	Remark
1	A0-	Odd bus
2	A0+	Odd bus
3	A1-	Odd bus
4	A1+	Odd bus
5	A2-	Odd bus
6	A2+	Odd bus
7	GND	–
8	ACLK-	Odd bus
9	ACLK+	Odd bus
10	A3-	Odd bus
11	A3+	Odd bus
12	B0-	Even bus
13	B0+	Even bus
14	GND	–
15	B1-	Even bus
16	B1+	Even bus
17	GND	–
18	B2-	Even bus
19	B2+	Even bus
20	BCLK-	Even bus
21	BCLK+	Even bus
22	B3-	Even bus
23	B3+	Even bus
24	GND	–
25	5V_PANEL	5 V Panel supply voltage
26	5V_PANEL	
27	5V_PANEL	
28	3V3_PANEL	3.3 V Panel supply voltage
29	3V3_PANEL	
30	3V3_PANEL	



Figure 8: LVDS Connector

X39: Backlight connector,

- Connector type: Molex 53398-1271
- Mating connector: Molex 51021-1200

Table 9: Backlight Connector

Pin	Signal	Remark
1	VCC_BKLT_OUT	Backlight voltage output
2		
3		
4	GND	–
5		
6		
7	NC	–
8	LCD0_BKLT_EN	Display 0 Backlight Enable output
9	LCD0_BKLT_CTRL	Display 0 Backlight (brightness) control
10	3V3_PROG ⁴	3.3 V input (programming)
11	EDID_CLK ⁵	EDID I ² C clock
12	EDID_DAT ⁵	EDID I ² C data

4: The EEPROM can be powered by the 3V3_PROG pin.

5: These pins can be used to program the on-board EDID EEPROM.



Figure 9: Backlight Connector

3.5.8 M.2 socket with M Key (for PCIe SSD devices)

The MB-COME6-4 provides one socket to support PCIe based M.2 SSD with 22 mm width and 80 mm length. A PCIe x4 interface is routed to this socket.

M.2 2280 single and double sided modules with M key (PCIe only) can be inserted.

The transfer rate of this interface mainly depends on the COM Express™ module and the connected device.

Please contact support@tq-group.com for further information about suitable M.2 SSDs.

3.5.9 M.2 socket with M Key (for PCIe SSD devices)

The MB-COME6-4 provides one socket to support PCIe based M.2 SSD with 22 mm width and 42 mm length. A PCIe x2 interface is routed to this socket.

M.2 2242 single and double sided modules with M key (PCIe only) can be inserted.

The transfer rate of this interface mainly depends on the COM Express™ module and the connected device.

Please contact support@tq-group.com for further information about suitable M.2 SSDs.

3.5.10 M.2 socket with B Key (for WWAN modules or SATA SSD devices)

The MB-COME6-4 provides a socket to support SATA based M.2 SSDs with 22 mm width and 80 mm length or modules with 22 mm width and 42 mm length.

1x USB 2.0 and SATA signals are routed to this socket.

For mounting the short module a distance cap from Würth 9779807025 is needed.

M.2 2280 / 2242 / 3042 single and double sided modules with B Key (SATA and USB 2.0 only) can be inserted.

The reachable transfer rate of this interface depends mainly on the module used and the connected device.

3.5.11 M.2 socket with E Key (for I/O devices)

The MB-COME6-4 provides a socket for an M.2 module with 22 mm width and 30 mm length.

1x USB 2.0 and PCIe x1 signals are routed to this socket.

M.2 2230 single and double sided modules with E or A+E key can be inserted.

The transfer rate of this interface mainly depends on the COM Express™ module and the connected device.

3.5.12 SATA Interfaces

The MB-COME6-4 supports two SATA interfaces:

- M.2 socket for M.2 B Key SSDs modules
- one standard 7-pin SATA connector

The transfer rates of these interfaces mainly depend on the COM Express™ module and the connected devices.

3.5.13 Audio

The MB-COME6-4 provides an audio codec to support following audio features:

- Microphone in (pink) ¹
- Headphone out (green)
- Line in (blue)

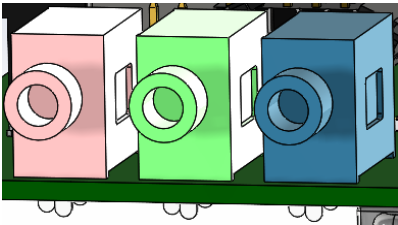

Figure 10: Audio Connectors X12, X13, X14

3.5.14 Fan Connector

The MB-COME6-4 provides a connector for 12 V fans.

- X26: 12 V fan connector
- Connector type: Tyco 640456-3
 - Mating connector: 3-pin fan connector (2.54 mm pitch)

Table 10: Fan Connector

Pin	Signal	Remark
1	GND	–
2	Fan Voltage	Output voltage (0 to 12 V PWM)
3	SENSE	Sense input for fan speed

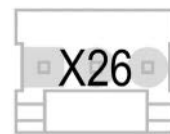

Figure 11: Fan Connector

3.5.15 PCI Express Connector

The MB-COME6-4 provides a standard PCI Express x16 slot connector.

The PCI Express port can be used for PCI Express graphics devices or high speed non-graphic PCI Express devices (e.g. quad Gigabit Ethernet or 10/40/100 Gigabit Ethernet controller).

- X19: Standard x16 PCI Express connector

The reachable transfer rate of this interface depends mainly on the COM Express module used and the connected device.

¹ Only microphones with external bias supply can be used.

3.5.16 Feature Connector

The MB-COME6-4 provides two pin header, where few COM Express™ signals are available.

This connector is for debug and software development purposes. The user can access to SMBus, I²C bus and a few other signals.

- Connector type: Male Pin header with 2-rows and 2,54 mm pitch
- Mating connector: Female Pin header with 2-rows and 2,54 mm pitch

Table 11: GPIO and COME Signal Connector X20

Pin	Signal	Remark
1	V_3V3_STBY	3.3 V supply
2	GND	-
3	V_3V3_STBY	3.3 V supply
4	GND	-
5	GPIO	Input
6	GPO0	Output
7	GPI1	Input
8	GPO1	Output
9	GPI2	Input
10	GPO2	Output
11	GPI3	Input
12	GPO3	Output
13	SMB_CK	SM bus clock
14	SUS_S3#	Suspend to RAM
15	SMB_DAT	SM bus data
16	SUS_S4#	Suspend to disk
17	SMB_ALERT#	SM bus alert
18	SUS_S5#	Soft off
19	BATLOW#	Battery low signal
20	COME_WDT	Come Watchdog Timer

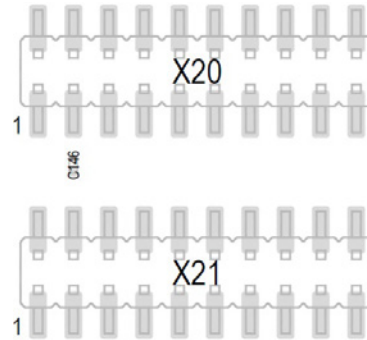

Figure 12: Feature Connectors

Table 12: I²C and COME Signal Connector X21

Pin	Signal	Remark
1	V_5V_STBY	5 V supply
2	GND	-
3	V_5V_STBY	5 V supply
4	GND	-
5	PWR_BTN#	Power Button
6	GND	-
7	RST_BTN#	Power Button
8	GND	-
9	I2C_CK	COM Express™ I ² C bus clock
10	BIOS_DIS0#	COM Express™ Boot from carrier SPI socket.
11	I2C_CK	COM Express™ I ² C bus clock
12	Wake1#	COM Express™ wake up signal
13	THRMTRIP#	Thermal shutdown signal from module
14	LID#	COM Express™ LID switch
15	SLEEP#	Sleep button signal to module
16	THRM#	COM Express™ input from off-Module temp sensor
17	SATA_ACT#	COM Express™ Serial ATA (activity indicator)
18	RAPID_SHUTDOWN	COM Express™ trigger for Rapid Shutdown
19	-	-
20	-	-

3.5.17 Debug LEDs

The MB-COME6-4 provides several LEDs for debug purposes.

Table 13: Debug LEDs

Function	PCB Text	Remark
Power	PWR	Green if 12 V input power is present
SUS S3	S3 act.	Green if module is in power-saving mode S3 (Suspend to RAM)
Power Good #	PWR GD#	Green if no PWR_OK signal is sent to module
Reset active	RST act.	Green if Reset is asserted

3.5.18 SPI Flash Socket

The MB-COME6-4 provides a socket for 3.3 V SPI flash. This is useful if a BIOS update fails or for BIOS development purposes. SPI-Flashes with SO8W package can be inserted.

If the "BIOS_DIS1#" jumper is set, the BIOS from the SPI flash in the socket is active.

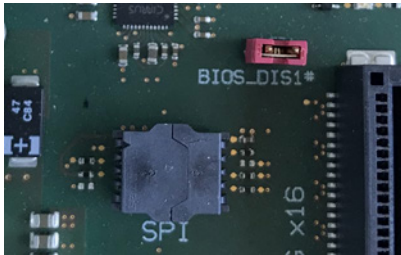

Figure 13: SPI socket and BIOS_DIS1# Jumper

3.5.19 COM Express™ Connector

The EPT 401-55103-51 or equivalent is used as COM Express™ connector. The stack height (board to board distance between carrier board and module) is 8 mm.

3.6 Buttons

3.6.1 Reset Button

The MB-COME6-4 provides an on board reset button, when the reset button is pressed, it triggers the COM Express™ module SYS_RESET# signal.

3.6.2 Power Button

The MB-COME6-4 provides an on board power button, when the power button is pressed, it triggers the COM Express™ module PWRBTN# signal. The triggered event usually initiates a power state transition (e.g. from S0 to S5).

4. MECHANICS

4.1 Dimensions

The dimensions are according to the Mini-ITX form factor, which is 170 mm × 170 mm. The following illustration shows the dimensions of the MB-COME6-4.

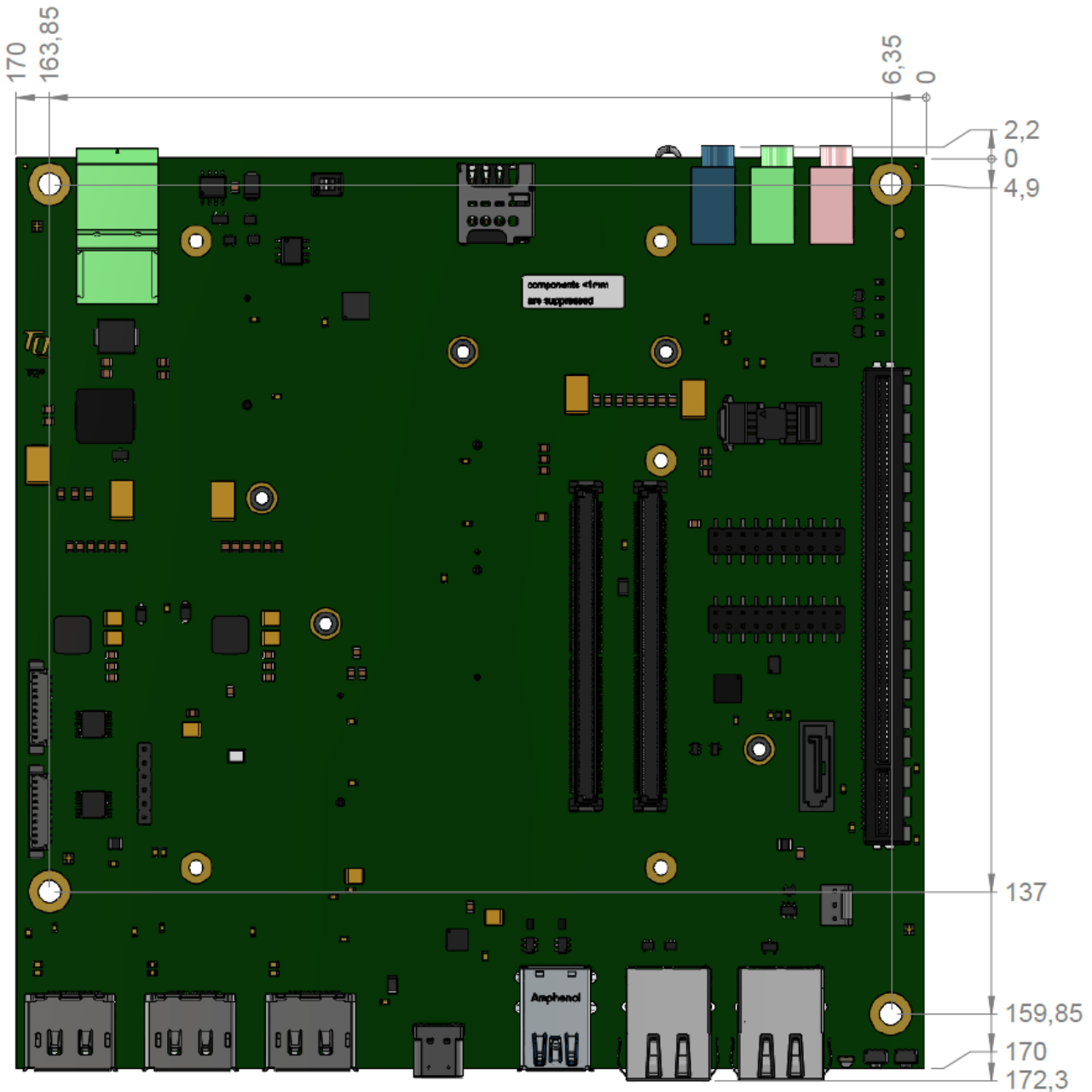

Figure 14: MB-COME6-4 Dimensions

Please contact support@tq-group.com for more details about 2D/3D Step models.

4.2 Protection Against External Effects

The MB-COME6-4 is not protected against dust, external impact and contact (IP00). Adequate protection has to be guaranteed by the surrounding system.

4.3 Labeling

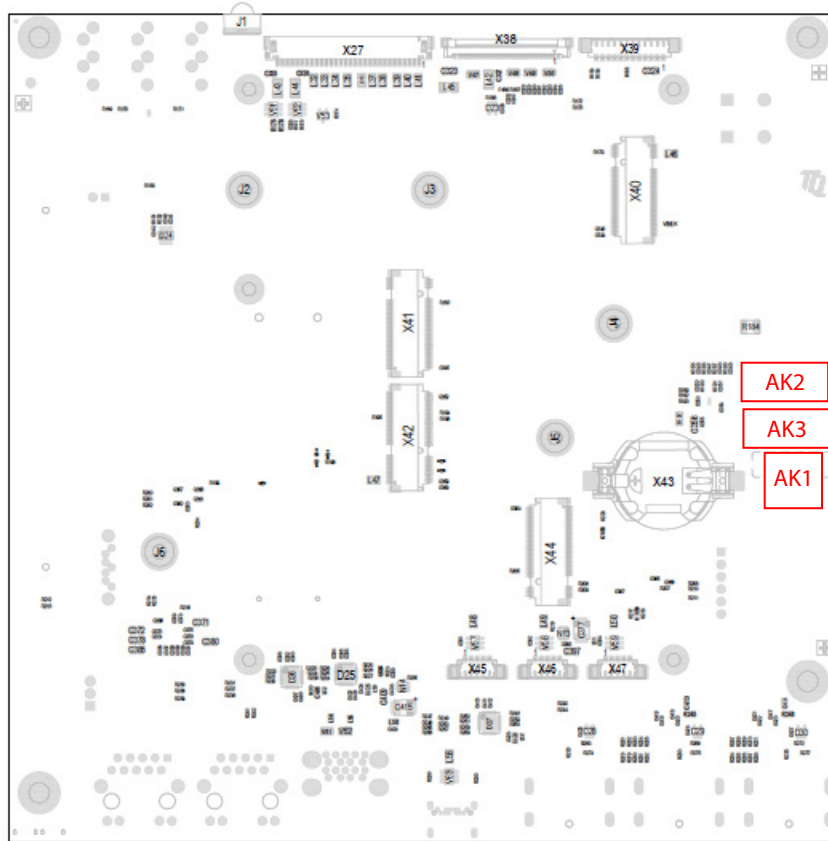

Figure 15: Position of labels

The labels on the MB-COME6-4 show the following information:

Table 14: Labels on MB-COME6-4

Label	Content
AK1	Serial number
AK2	MB-COME6-4 version and revision, tests performed
AK3	MAC address



5. SOFTWARE

5.1 System Resources

5.1.1 I²C Bus

The general purpose I²C bus (COM Express™ pin names I2C_DAT and I2C_CK) is accessible on the I²C and feature connector. The following table shows the I²C address mapping for the General Purpose I²C bus:

Table 15: I²C Address Mapping

8-bit Address	Function	Device	Remark
0x2E	EEPROM	24AA32AT-I/MC	COM Express™ Carrier EEPROM

5.1.2 SMBus

The SMBus (System Management Bus) on the MB-COME6-4 is routed to the PCIe card (optional) and to the feature connector. On this bus no device is connected.

5.2 Driver Download

The MB-COME6-4 module is well supported by the standard operating systems, which already include most of the drivers required. It is recommended to use the latest drivers for optimal performance and the full feature set of the module.

Drivers for the Intel® i225 Gigabit Ethernet controller can be downloaded from this Intel® page:

- Intel® Download Center: Intel® Ethernet Controller i225 Series
<https://www.intel.com/content/www/us/en/products/details/ethernet/gigabit-controllers/i225-controllers.html>

Please contact support@tq-group.com for further driver download assistance.



6. SAFETY REQUIREMENTS AND PROTECTIVE REGULATIONS

6.1 EMC

The MB-COME6-4 was developed according to the requirements of electromagnetic compatibility (EMC). Depending on the target system, anti-interference measures may still be necessary to guarantee that the limits for the overall system including housing are met.

6.2 ESD

In order to avoid interspersions on the signal path from the input to the protection circuit in the system, the protection against electrostatic discharge should be arranged directly at the inputs of a system. Most external interfaces are protected using ESD protection diodes. Measurements for ESD protection have to be done with the electronic parts mounted in a housing. Since TQ-Systems GmbH does not offer a housing for the MB-COME6-4, no special preventive measures are taken.

6.3 Operational Safety and Personal Security

Due to the occurring voltages (12 V DC), tests with respect to the operational and personal safety have not been carried out.

6.4 Reliability and Service Life

6.4.1 RoHS

The MB-COME6-4 is manufactured RoHS compliant.

- All components and assemblies are RoHS compliant
- The soldering processes are RoHS compliant

6.5 WEEE®

The final distributor is responsible for compliance with the WEEE® regulation.

Within the scope of the technical possibilities, the MB-COME6-4 was designed to be recyclable and easy to repair.

6.6 REACH®

The EU-chemical regulation 1907/2006 (REACH® regulation) stands for registration, evaluation, certification and restriction of substances SVHC (Substances of very high concern, e.g., carcinogen, mutagen and/or persistent, bio accumulative and toxic). Within the scope of this juridical liability, TQ-Systems GmbH meets the information duty within the supply chain with regard to the SVHC substances, insofar as suppliers inform TQ-Systems GmbH accordingly.

6.7 EuP

The Eco Design Directive, also Energy using Products (EuP), is applicable to products for the end user with an annual quantity >200,000. The MB-COME6-4 must therefore always be seen in conjunction with the complete device. The available standby and sleep modes of the components on the MB-COME6-4 enable compliance with EuP requirements for the MB-COME6-4.

6.8 Battery

No batteries are assembled on the MB-COME6-4 by default. The MB-COME6-4 provides a battery socket, which can be equipped with a CR2032, 3.0 V lithium coin cell. The MB-COME6-4 provides current limiting circuitry and protection against reverse current.

6.9 Packaging

The MB-COME6-4 is delivered in reusable packaging.



6.10 Other Entries

By environmentally friendly processes, production equipment and products, we contribute to the protection of our environment. The energy consumption of this subassembly is minimised by suitable measures.

Due to the fact that at the moment there is still no technical equivalent alternative for printed circuit boards with bromine-containing flame protection (FR-4 material), such printed circuit boards are still used.

Capacitors and transformers containing PCB (polychlorinated biphenyls) are not used.

These points are an essential part of the following laws:

- The law to encourage the circular flow economy and assurance of the environmentally acceptable removal of waste as at 27.9.94
(source of information: BGBl I 1994, 2705)
- Regulation with respect to the utilization and proof of removal as at 1.9.96
(source of information: BGBl I 1996, 1382, (1997, 2860))
- Regulation with respect to the avoidance and utilization of packaging waste as at 21.8.98
(source of information: BGBl I 1998, 2379)
- Regulation with respect to the European Waste Directory as at 1.12.01
(source of information: BGBl I 2001, 3379)

This information is to be seen as notes. Tests or certifications were not carried out in this respect.

7. APPENDIX

7.1 Acronyms and Definitions

The following acronyms and abbreviations are used in this document.

Table 16: Acronyms

Acronym	Meaning
ATA	Advanced Technology Attachment
BIOS	Basic Input/Output System
CPU	Central Processing Unit
CSM	Compatibility Support Module
DC	Direct Current
DDC	Display Data Channel
DDI	Digital Display Interface
DDR3L	DDR3 Low Voltage
DMA	Direct Memory Access
DP	Display Port
DP	DisplayPort
DVI	Digital Visual Interface
ECC	Error-Correcting Code
EDID	Extended Display Identification Data
eDP	embedded DisplayPort
EEPROM	Electrically Erasable Programmable Read-Only Memory
EMC	Electromagnetic Compatibility
eSATA	external Serial ATA
ESD	Electrostatic Discharge
FAE	Field Application Engineer
FIFO	First In First Out
flexiCFG	Flexible Configuration
FPGA	Field Programmable Gate-Array
FR-4	Flame Retardant 4
GND	Ground
GPIO	General Purpose Input/Output
HD	High Definition
HD	High Definition (Audio)
HDA	High Definition Audio
HDD	Hard Disk Drive
HDMI	High Definition Multimedia Interface
HPD	Hot Plug Detect
HSP	Heat Spreader
I	Input
I PD	Input with internal Pull-Down resistor
I PU	Input with internal Pull-Up resistor
I/O	Input/Output
I ² C	Inter-Integrated Circuit
IEEE®	Institute of Electrical and Electronics Engineers
IP	Ingress Protection
IRQ	Interrupt Request
iRTC	Industrial Real Time Clock
LED	Light Emitting Diode
LP	Low-Profile
LPC	Low Pin Count
LTE	Long Term Evolution
LVDS	Low Voltage Differential Signal

Table 15: Acronyms (continued)

Acronym	Meaning
MMC	Multimedia Card
mSATA	Mini-SATA
MTBF	Mean operating Time Between Failures
NC	Not Connected
O	Output
OD	Open drain output
OpROM	Option ROM
PC	Personal Computer
PCB	Printed Circuit Board
PCI	Peripheral Component Interconnect
PCIe	Peripheral Component Interconnect express
PCMCIA	People Can't Memorize Computer Industry Acronyms
PD	Pull-Down
PICMG®	PCI Industrial Computer Manufacturers Group
PU	Pull-Up
PWM	Pulse-Width Modulation
PWR	Power
RAM	Random Access Memory
RMA	Return Merchandise Authorization
RoHS	Restriction of (the use of certain) Hazardous Substances
RS-232	Recommended Standard (serial interface)
RTC	Real-Time Clock
SATA	Serial ATA
SCU	System Control Unit
SD	Secure Digital
SD/MMC	Secure Digital Multimedia Card
SDRAM	Synchronous Dynamic Random Access Memory
SIM	Subscriber Identity Module
SMB	System Management Bus
SO-DIMM	Small Outline Dual In-Line Memory Module
SPD	Serial Presence Detect
SPI	Serial Peripheral Interface
SSD	Solid-State Drive
TDP	Thermal Design Power
TPM	Trusted Platform Module
UART	Universal Asynchronous Receiver/Transmitter
uEFI	Unified Extensible Firmware Interface
UMTS	Universal Mobile Telecommunications System
USB	Universal Serial Bus
VGA	Video Graphics Array (640 × 480)
WEEE®	Waste Electrical and Electronic Equipment
WES	Microsoft® Windows® Embedded Standard
WLAN	Wireless Local Area Network



7.2 References

Table 17: Further Applicable Documents and Links

No.	Name	Rev. / Date	Company
(1)	PICMG® COM0 COM Express™ Module Base Specification	Rev. 3.0 / March 31, 20217	PICMG®
(2)	PICMG® COM Express™ Carrier Design Guide (available for public download) https://www.picmg.org/wp-content/uploads/PICMG_COMDG_2.0-RELEASED-2013-12-061.pdf	Rev. 2.0 / Dec. 6, 2013	PICMG®

