



# MB-COME6-2 User's Manual

MB-COME6-2 UM 0100  
2016-10-31







## TABLE OF CONTENTS

1.	ABOUT THIS MANUAL.....	1
1.1	Copyright and Licence Expenses .....	1
1.2	Registered Trademarks.....	1
1.3	Disclaimer.....	1
1.4	Imprint.....	1
1.5	Service and Support.....	1
1.6	Tips on Safety .....	2
1.7	Symbols and Typographic Conventions.....	2
1.8	Handling and ESD Tips .....	2
1.9	Naming of Signals.....	3
1.10	Further Applicable Documents / Presumed Knowledge.....	3
2.	INTRODUCTION .....	4
2.1	Functional Overview .....	4
2.2	Specification Compliance.....	4
2.3	Accessories.....	5
3.	FUNCTIONAL SPECIFICATION.....	6
3.1	Block Diagram .....	6
3.2	Electrical Specification.....	7
3.2.1	Supply Voltage Characteristics .....	7
3.2.2	Power Consumption Specification .....	7
3.3	Environmental Specification .....	7
3.4	System Components.....	7
3.4.1	Gigabit Ethernet Controller.....	7
3.4.2	HD-Audio .....	7
3.4.3	USB Hub.....	7
3.5	Connectors and Interfaces .....	8
3.5.1	Power Supply .....	10
3.5.2	DisplayPort.....	10
3.5.3	HDMI .....	10
3.5.4	USB Host Interfaces .....	10
3.5.5	Gigabit Ethernet.....	11
3.5.6	Serial Interface (RS-232) .....	11
3.5.7	Embedded Display Port .....	12
3.5.8	LVDS .....	13
3.5.9	Mini PCIe Socket.....	15
3.5.10	M.2 Socket with E-Keying (for I/O devices).....	15
3.5.11	M.2 Socket with M-Keying (for SSD devices) .....	15
3.5.12	SATA Interfaces.....	15
3.5.13	Audio.....	16
3.5.14	Fan Connector.....	16
3.5.15	Riser Interface.....	17
3.5.16	Power and Reset Button Connector .....	17
3.5.17	I <sup>2</sup> C and COME Connector.....	17
3.5.18	Debug LEDs.....	18
3.5.19	SPI Flash Socket .....	18
3.5.20	COM Express™ Connector .....	18
4.	MECHANICS .....	19
4.1	Dimensions .....	19
4.2	Protection Against External Effects .....	19
5.	SOFTWARE.....	20
5.1	System Resources .....	20
5.1.1	I <sup>2</sup> C Bus .....	20
5.1.2	SMBus .....	20
5.2	Operating Systems .....	20
5.2.1	Supported Operating Systems.....	20
5.2.2	Driver Download .....	20



## TABLE OF CONTENTS (continued)

6.	SAFETY REQUIREMENTS AND PROTECTIVE REGULATIONS.....	21
6.1	EMC.....	21
6.2	ESD.....	21
6.3	Operational Safety and Personal Security.....	21
6.4	Reliability and Service Life.....	21
6.4.1	RoHS Compliance.....	21
6.4.2	WEEE Regulation.....	21
6.5	Other Entries.....	21
7.	APPENDIX.....	22
7.1	Acronyms and Definitions.....	22
7.2	References.....	23

## TABLE DIRECTORY

Table 1:	Terms and Conventions.....	2
Table 2:	Pinout Power-In Connector X12.....	10
Table 3:	Pinout USB Host Extension Connectors X28, X29, X30.....	10
Table 4:	Serial Port COM Express™ Port Mapping.....	11
Table 5:	eDP Connector X23.....	12
Table 6:	LVDS Connector X24.....	13
Table 7:	Backlight Power Connector X13.....	14
Table 8:	Backlight Connector X25.....	14
Table 9:	Speaker Connector for Right Speaker X35.....	i
Table 10:	Speaker Connector for Left Speaker X38.....	i
Table 11:	12 V Fan Connector X22.....	i
Table 12:	Power and Reset Button Connector X39.....	i
Table 13:	I <sup>2</sup> C and COME Connector X26.....	17
Table 14:	Debug LEDs.....	18
Table 15:	I <sup>2</sup> C Address Mapping COM Express™ SMBus Port.....	20
Table 16:	Acronyms.....	22
Table 17:	Further Applicable Documents and Links.....	23

## ILLUSTRATION DIRECTORY

Illustration 1:	Block Diagram MB-COME6-2.....	6
Illustration 2:	MB-COME6-2, Top.....	8
Illustration 3:	MB-COME6-2, Bottom.....	9
Illustration 4:	RS-232 D-SUB Connector X32.....	11
Illustration 5:	eDP Connector X23.....	12
Illustration 6:	LVDS Connector X24.....	13
Illustration 7:	Backlight Connector X25.....	14
Illustration 8:	2.5" HDD/SSD Mounting.....	15
Illustration 9:	Speaker Connector X35.....	16
Illustration 10:	Speaker Connector X38.....	16
Illustration 11:	12 V Fan Connector X22.....	16
Illustration 12:	PCIe card Installation Configuration.....	17
Illustration 13:	PWR and RST Button X39.....	17
Illustration 14:	12 V Fan Connector X26.....	17
Illustration 15:	MB-COME6-2 dimensions.....	19

## REVISION HISTORY

Rev.	Date	Name	Pos.	Modification
0100	2016-10-31	FP		First edition



## 1. ABOUT THIS MANUAL

### 1.1 Copyright and Licence Expenses

Copyright protected © 2016 by TQ-Systems GmbH.

This User's Manual may not be copied, reproduced, translated, changed or distributed, completely or partially in electronic, machine readable, or in any other form without the written consent of TQ-Systems GmbH.

The drivers and utilities for the components used as well as the BIOS are subject to the copyrights of the respective manufacturers. The licence conditions of the respective manufacturer are to be adhered to.

BIOS-licence expenses are paid by TQ-Systems GmbH and are included in the price.

Licence expenses for the operating system and applications are not taken into consideration and must be separately calculated / declared.

### 1.2 Registered Trademarks

TQ-Systems GmbH aims to adhere to the copyrights of all the graphics and texts used in all publications, and strives to use original or license-free graphics and texts.

All the brand names and trademarks mentioned in the publication, including those protected by a third party, unless specified otherwise in writing, are subjected to the specifications of the current copyright laws and the proprietary laws of the present registered proprietor without any limitation. One should conclude that brand and trademarks are rightly protected by a third party.

### 1.3 Disclaimer

TQ-Systems GmbH does not guarantee that the information in this User's Manual is up-to-date, correct, complete or of good quality. Nor does TQ-Systems GmbH assume guarantee for further usage of the information. Liability claims against TQ-Systems GmbH, referring to material or non-material related damages caused, due to usage or non-usage of the information given in the User's Manual, or due to usage of erroneous or incomplete information, are exempted, as long as there is no proven intentional or negligent fault of TQ-Systems GmbH.

TQ-Systems GmbH explicitly reserves the rights to change or add to the contents of this User's Manual or parts of it without special notification.

### 1.4 Imprint

TQ-Systems GmbH  
Gut Delling, Mühlstraße 2  
**D-82229 Seefeld**

Tel: +49 (0) 8153 9308-0

Fax: +49 (0) 8153 9308-4223

Email: [info@tq-group.com](mailto:info@tq-group.com)

Web: <http://www.tq-group.com/>

### 1.5 Service and Support

Please visit our website [www.tq-group.com](http://www.tq-group.com) for latest product documentation, drivers, utilities and technical support.

You can register on our website [www.tq-group.com](http://www.tq-group.com) to have access to restricted information and automatic update services.

For direct technical support you can contact our FAE team by email: [support@tq-group.com](mailto:support@tq-group.com).

Our FAE team can also support you with additional information like 3D-STEP files and confidential information, which is not provided on our public website.





For service/RMA, please contact our service team by email ([service@tq-group.com](mailto:service@tq-group.com)) or your sales team at TQ.

## 1.6 Tips on Safety

Improper or incorrect handling of the product can substantially reduce its life span.

## 1.7 Symbols and Typographic Conventions

Table 1: Terms and Conventions

Symbol	Meaning
	This symbol represents the handling of electrostatic-sensitive modules and / or components. These components are often damaged / destroyed by the transmission of a voltage higher than about 50 V. A human body usually only experiences electrostatic discharges above approximately 3,000 V.
	This symbol indicates the possible use of voltages higher than 24 V. Please note the relevant statutory regulations in this regard. Non-compliance with these regulations can lead to serious damage to your health and also cause damage / destruction of the component.
	This symbol indicates a possible source of danger. Acting against the procedure described can lead to possible damage to your health and / or cause damage / destruction of the material used.
	This symbol represents important details or aspects for working with TQ-products.
<b>Command</b>	A font with fixed-width is used to denote commands, contents, file names, or menu items.

## 1.8 Handling and ESD Tips

General handling of your TQ-products

	<p>The TQ-product may only be used and serviced by certified personnel who have taken note of the information, the safety regulations in this document and all related rules and regulations.</p> <p>A general rule is: do not touch the TQ-product during operation. This is especially important when switching on, changing jumper settings or connecting other devices without ensuring beforehand that the power supply of the system has been switched off.</p> <p>Violation of this guideline may result in damage / destruction of the MB-COME6-2 module and be dangerous to your health.</p> <p>Improper handling of your TQ-product would render the guarantee invalid.</p>
---	---

Proper ESD handling

	<p>The electronic components of your TQ-product are sensitive to electrostatic discharge (ESD). Always wear antistatic clothing, use ESD-safe tools, packing materials etc., and operate your TQ-product in an ESD-safe environment. Especially when you switch modules on, change jumper settings, or connect other devices.</p>
---	---



## 1.9 Naming of Signals

A hash mark (#) at the end of the signal name indicates a low-active signal.

Example: RESET#

If a signal can switch between two functions and if this is noted in the name of the signal, the low-active function is marked with a hash mark and shown at the end.

Example: C / D#

If a signal has multiple functions, the individual functions are separated by slashes when they are important for the wiring. The identification of the individual functions follows the above conventions.

Example: WE2# / OE#

## 1.10 Further Applicable Documents / Presumed Knowledge

- **Specifications and manual of the modules used:**  
These documents describe the service, functionality and special characteristics of the module used.
- **Specifications of the components used:**  
The manufacturer's specifications of the components used, for example CompactFlash cards, are to be taken note of. They contain, if applicable, additional information that must be taken note of for safe and reliable operation. These documents are stored at TQ-Systems GmbH.
- **Chip errata:**  
It is the user's responsibility to make sure all errata published by the manufacturer of each component are taken note of. The manufacturer's advice should be followed.
- **Software behaviour:**  
No warranty can be given, nor responsibility taken for any unexpected software behaviour due to deficient components.
- **General expertise:**  
Expertise in electrical engineering / computer engineering is required for the installation and the use of the device.

Implementation information for the carrier board design is provided in the COM Express™ Design Guide (2) maintained by the PICMG®. This Carrier Design Guide includes a very good guideline to design a COM Express™ carrier board.

It includes detailed information with schematics and detailed layout guidelines.

Please refer to the official PICMG® documentation for additional information (1), (2).



## 2. INTRODUCTION

The COM Express™ mainboard MB-COME6-2 is a carrier board for COM Express™ modules with Type 6 pinout. It can be used for panel PCs, embedded computers or as evaluation platform for COM Express™ modules. In combination with a standard COM Express™ module it forms a very compact hardware kit that can be used for a freely scalable embedded PC platform thanks to its modular design. Because of this – with uniform interfaces and dimensions – the PC system can be easily adapted to suit the requirements of the application. The many extension options and storage media, which can be added, offer a high level of flexibility and allow functionalities and performance to be extended easily, quickly and inexpensively.

Typical usage is in embedded server applications, PC systems for medical applications, automation, visualisation and monitoring and all applications that place high demands on quality, durability and long-term availability.

### 2.1 Functional Overview

The following key functions are implemented on the MB-COME6-2:

#### Supported Modules:

- COM Express™ Mini Modules with Type 6 pinout

#### External Interfaces:

- 2 × Gigabit Ethernet (isolated for medical applications)
- 4 × USB3.0
- 2 × HDMI
- 1 × DisplayPort
- Audio (headphone out and microphone in)
- Power Button / Reset

#### Internal Interfaces:

- LVDS or eDP
- 4 × USB
- Mini PCIe socket (with micro SIM Card support)
- M.2 socket with E-Keying (e.g. for WLAN / Bluetooth cards)
- M.2 socket with M-Keying (for SSDs)
- Socket for 2.5" HDD/SSD
- 2 × SATA interface
- Audio: stereo speaker out (2 × 1.4 W amplifier)
- RS-232
- Riser interface to support PCIe or PCI add in cards via an appropriate riser card

#### Power supply:

- Voltage: 12 V DC ±5 %

#### Environment:

- Extended temperature: –20 °C to +85 °C

#### Form factor / dimensions:

- 170 × 170 mm<sup>2</sup> (Mini ITX)

### 2.2 Specification Compliance

The MB-COME6-2 supports modules compliant to the PICMG® COM Express™ Module Base Specification (COM.0 R2.1) with Type 6 pinout with compact or basic form factors.





### 2.3 Accessories

- **COMSET-HDD**  
Mounting Set for 2.5" HDD/SSD on the MB-COME6-2  
Order code: 221803.0100
- **RISER-PCIE-PCIE-1**  
Riser for 1 × PCIe; PCIe card is in line with the MB-COME6-2  
Order code: 285846.0100
- **RISER-PCIE-PCI-1**  
Riser for 1 × PCI; PCI card is in line with the MB-COME6-2  
Order code: 285648.0100
- **DK-USB-TYPA-MOL5**  
Adapter cable from internal USB connector to an A-Type receptacle, 150 mm long  
Order code: 277130.0100
- **DSUB-ADAPTER DK-RS232-9POL-DSUB-PICOBLADE**  
Adapter cable from internal connector to a 9-pin D-Sub male connector, 150 mm long  
Order code: 278622.0100

Please contact [support@tq-group.com](mailto:support@tq-group.com) for details about Display Port cables and Display Port to DVI/HDMI adapters.



### 3. FUNCTIONAL SPECIFICATION

#### 3.1 Block Diagram

The following illustration shows the block diagram of the MB-COME6-2:

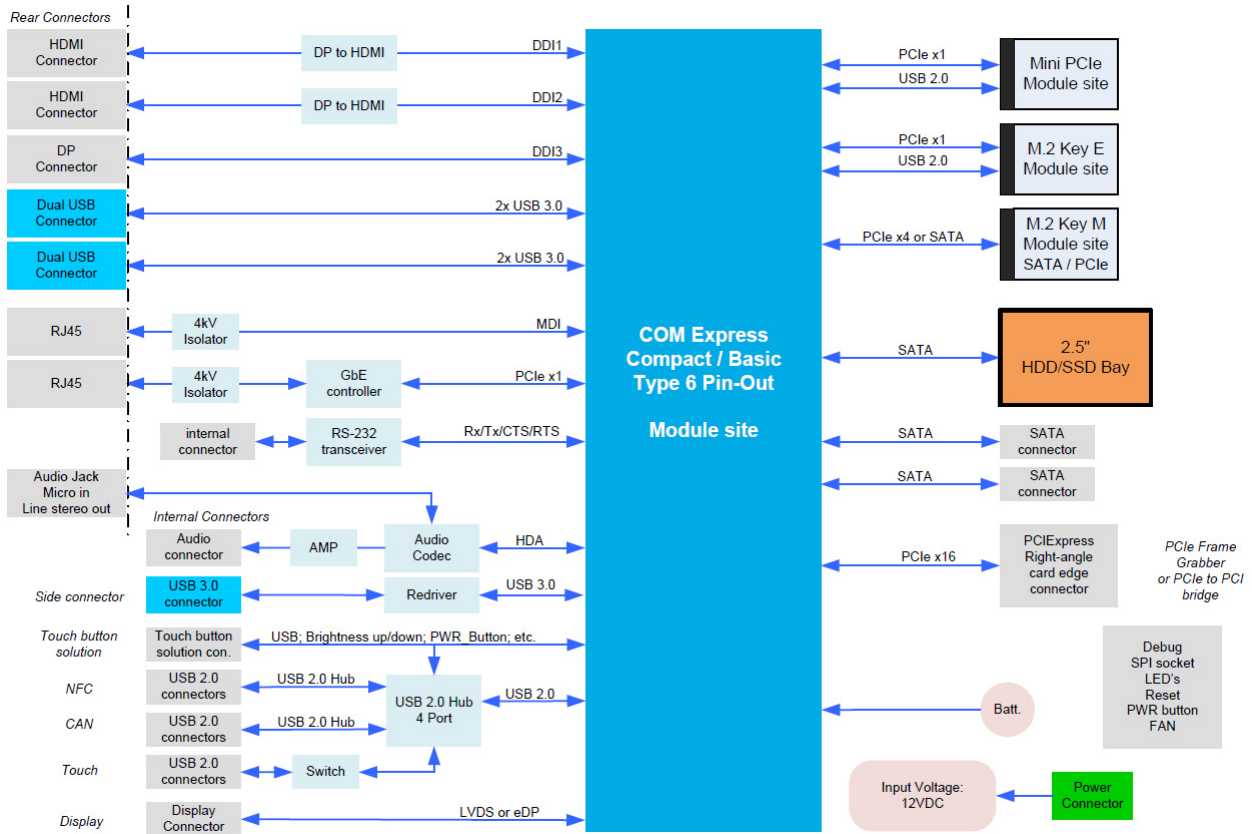

Illustration 1: Block Diagram MB-COME6-2

## 3.2 Electrical Specification

### 3.2.1 Supply Voltage Characteristics

The MB-COME6-2 requires an input voltage of 12 V DC  $\pm 5\%$ .

The input voltages shall rise from 10 % of nominal to 90 % of nominal within 0.1 ms to 20 ms ( $0.1 \text{ ms} \leq \text{Rise Time} \leq 20 \text{ ms}$ ). There must be a smooth and continuous increase of each DC output voltage from 10 % to 90 % of its final set point within the regulation range.

### 3.2.2 Power Consumption Specification

The power consumption of the system significantly depends on the connected devices (COM Express™ module, Mass storage devices, USB devices, display backlight, speakers etc.).

The power consumption of the MB-COME6-2 itself is approximately 130 mA @ 12 V (COM Express™ module supplied externally; UEFI-shell active; no keyboard, no mouse, no mass storage device, no Ethernet cable etc. connected).

The maximum input current of the MB-COME6-2 is limited to 7 A by a fuse. The load caused by devices connected to the carrier board should not exceed 60 W.

#### Note: Power requirement



The power supply for the MB-COME6-2 must be configured with enough reserve. It should be calculated with the maximum power of all connected components.

## 3.3 Environmental Specification

- Operating temperature, extended:  $-20\text{ °C}$  to  $+85\text{ °C}$
- Storage temperature:  $-40\text{ °C}$  to  $+85\text{ °C}$
- Relative humidity (operating / storage): 10 % to 90 % (not condensing)

## 3.4 System Components

### 3.4.1 Gigabit Ethernet Controller

The MB-COME6-2 provides an Intel® i210IT Ethernet controller with 10/100/1000 Mbps speed and IEEE1588 support. Please contact [support@tq-group.com](mailto:support@tq-group.com) for further information about the IEEE1588 support.

### 3.4.2 HD-Audio

The MB-COME6-2 provides a Realtek ALC262 High Definition Audio Codec and a stereo Class D Amplifier with 1.4 W output power per channel (@ 8  $\Omega$ ).

### 3.4.3 USB Hub

The MB-COME6-2 provides a Microchip USB2514 with 4 Hi-Speed downstream ports.

### 3.5 Connectors and Interfaces

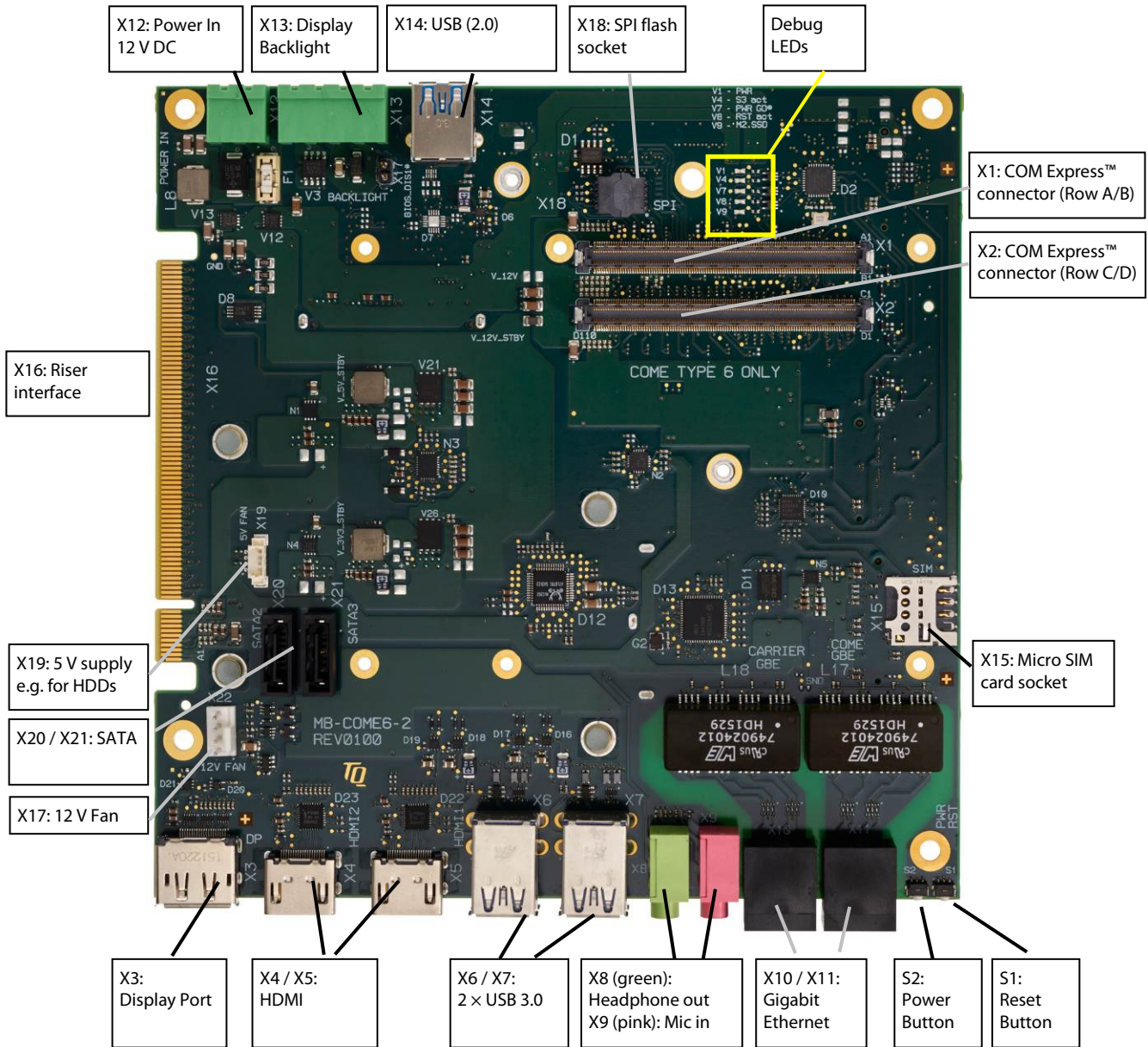

Illustration 2: MB-COME6-2, Top

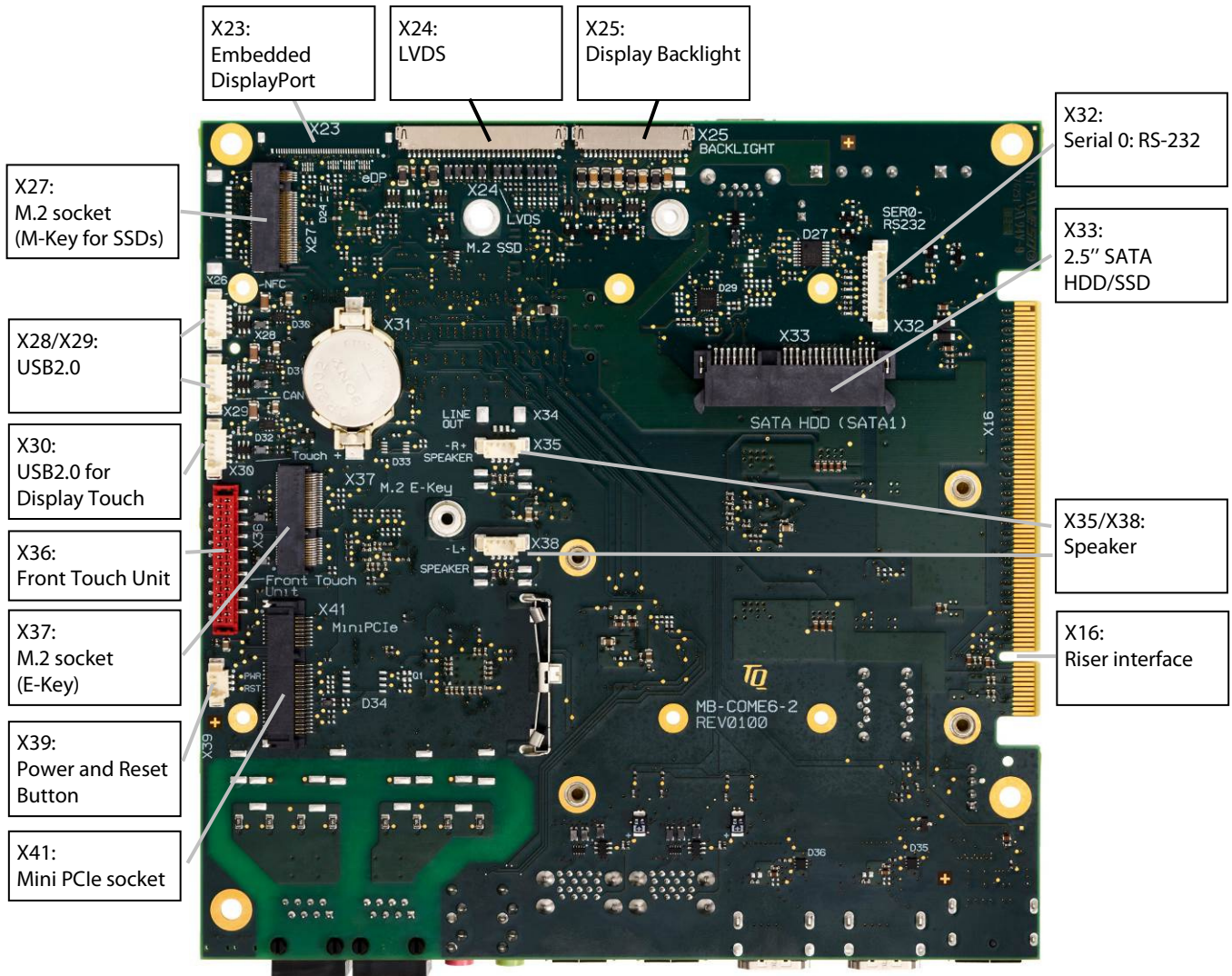

Illustration 3: MB-COME6-2, Bottom

### 3.5.1 Power Supply

The MB-COME6-2 requires a single 12 V DC power supply. The voltage should not vary more than  $\pm 5\%$ .

#### X10: Power-In Connector

- Connector type: Phoenix MSTBA 2,5/ 2-G-5,08
- Mating connector: Phoenix MSTBA 2,5/ 2-ST-5,08

Table 2: Pinout Power-In Connector X12

Pin	Signal	Remark
1	12 V	Fused @ 7 A
2	GND	-

### 3.5.2 DisplayPort

The MB-COME6-2 supports one DisplayPort interface. The support of the interface and of adapters from DP to HDMI, DVI or VGA depends on the combination of the COM Express™ module and the adapter used. The combination of some modules with some adapters might not work.

### 3.5.3 HDMI

The MB-COME6-2 supports two HDMI interfaces. Each interface provides an NXP PTN3366 HDMI level shifter with high bandwidth, low power consumption and ESD protection. The support of the interfaces and possible adapters depends on the combination of the COM Express™ module and the adapter used. The combination of some modules with some adapters might not work.

### 3.5.4 USB Host Interfaces

The MB-COME6-2 supports several USB Host interfaces.

X6 / X7: Double A-Type (USB3.0) connector for direct usage of USB host ports

X14: A-Type connector for direct usage of a USB 2.0 host port. USB3.0 is only available at this connector with a special version of the MB-COME6-2 and a TQMx60EB -COM Express™ module with a special BIOS

X28 / X29 / X30: USB host extension connector for usage of a USB host port with an adapter cable

- Connector type: Molex 53398-0571
- Mating connector: Molex 51021-0500

Table 3: Pinout USB Host Extension Connectors X28, X29, X30

Pin	Signal	Cable Colour	Remark
1	+5 V	Red	-
2	D-	White	-
3	D+	Green	-
4	GND	Black	-
5	GND	-	-

### 3.5.5 Gigabit Ethernet

The MB-COME6-2 supports two common Gigabit Ethernet ports.

The Ethernet signals of the COM Express™ connector are routed to X11.

An Intel® i210IT Ethernet controller with 10/100/1000 Mbps speed implemented on the MB-COME6-2 is connected to X10.

Special Ethernet Magnetics and Ethernet Jacks are used for both interfaces to comply with the requirements according to IEC60601-1 3<sup>rd</sup> edition (standard for medical electrical equipment) to realize at least 1 × MOOP (means of operator protection). Because of this isolation requirements and limited front panel space there are no LEDs indicating activity or connection speed of the Ethernet interfaces.

### 3.5.6 Serial Interface (RS-232)

The MB-COME6-2 supports one serial port:

- RS-232 port at on-board connector

The COM Express™ Specification does only provide signal definitions for RX and TX lines for the serial interface. Due to the TQ-flexiCFG feature, the serial ports can be configured to route the handshake signals to free pins on the COM Express connector.

Table 4: Serial Port COM Express™ Port Mapping

COM Express Signal	COM Express Pin	MB-COME6-2	Remark
SER0_TX	A98	SER0_TX	3.3 V input
SER0_RX	A99	SER0_RX	3.3 V output
SER1_TX	A101	SER1_TX	3.3 V input (not available)
SER1_RX	A102	SER1_RX	3.3 V output (not available)
SER0_RTS# <sup>1</sup>	B98	SER0_RTS#	3.3 V input
SER0_CTS# <sup>1</sup>	B99	SER0_CTS#	3.3 V output
SER1_RTS# <sup>1</sup>	D24	SER1_RTS#	3.3 V input (not available)
SER1_CTS# <sup>1</sup>	D25	SER1_CTS#	3.3 V output (not available)

The four COM Express™ serial signals (RX/TX) are specified to provide a protection and level shifter circuit.

The implementation of this circuit would result in a lower transfer speed on the two serial ports of the COM Express™ module.

On the MB-COME6-2 the protection circuit is removed and the serial ports provide a transfer rate of up to 115 kbaud.

The MB-COME6-2 can only be used in combination with COM Express™ modules with Type 6 pinout.

Table 1: RS-232 D-Sub Connector X32

Pin	RS-232 Signal (all signals)	MB-COME6-2	D-Sub connector (with DSUB-Adaptor)
1	DCD	NC <sup>3</sup>	-
2	DSR	NC <sup>3</sup>	RXD
3	RXD	RXD	TXD
4	RTS	RTS <sup>2</sup>	-
5	TXD	TXD	GND
6	CTS	CTS <sup>2</sup>	-
7	DTR	NC <sup>3</sup>	RTS
8	RI	NC <sup>3</sup>	CTS
9	GND	GND	-
10	-	NC	-

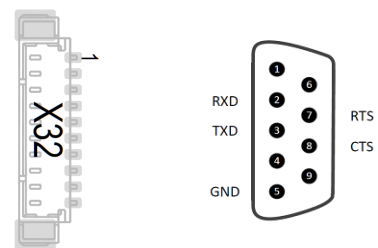

Illustration 4: RS-232 D-SUB Connector X32

1: These signals are not specified in COM Express™ specification.

These signals are only available when the TQ flexiCFG feature is available on the COM Express™ module. TQ modules support this feature.

2: Only available when the TQ flexiCFG feature is available on the COM Express™ module.

3: Not available since signal is not defined in COM Express™ specification.

### 3.5.7 Embedded Display Port

The MB-COME6-2 supports an embedded DisplayPort (eDP) interface where suitable displays can be connected directly. This functionality is only available with an eDP variant of the MB-COME6-2 and if the connected COM Express™ module supports eDP. LVDS is not available with the eDP variant.

Please contact [support@tq-group.com](mailto:support@tq-group.com) for further information about eDP or LVDS support.

X30: eDP connector

- Connector type: JAE HD1S040HA1
- Mating connector: JAE HD1P040MA1

Table 5: eDP Connector X23

Pin	Signal	Remark
1	NC	–
2	GND	–
3	TX3–	Lane 3 differential pair
4	TX3+	
5	GND	–
6	TX2–	Lane 2 differential pair
7	TX2+	
8	GND	–
9	TX1–	Lane 1 differential pair
10	TX1+	
11	GND	–
12	TX0–	Lane 0 differential pair
13	TX0+	
14	GND	–
15	AUX+	AUX - channel
16	AUX–	
17	GND	–
18	3V3	3.3 V supply voltage
19	3V3	
20	3V3	
21	3V3	
22	NC	–
23	GND	–
24	GND	
25	GND	
26	GND	
27	HPD	Hot Plug Detect
28	GND	–
29	GND	
30	GND	
31	GND	
32	BLKT_EN	Backlight enable
33	BLKT_CTRL	Backlight (brightness) control
34	VDD_EN	Panel power enable
35	AUX_SEL	Low ⇒ AUX; High ⇒ I <sup>2</sup> C
36	V_BLKT	12 V Backlight supply voltage
37	V_BLKT	
38	V_BLKT	
39	V_BLKT	
40	NC	–

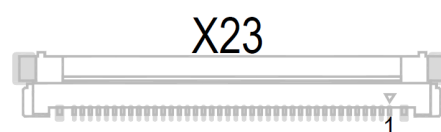

Illustration 5: eDP Connector X23



### 3.5.8 LVDS

The MB-COME6-2 supports an LVDS interface where suitable displays can be connected directly. This functionality is only available with an LVDS variant of the MB-COME6-2 and if the connected COM Express™ module supports LVDS. eDP is not available with the LVDS variant.

There are also connectors to power the backlight of the connected display.

The MB-COME6-2 has an on-board EDID EEPROM to store display specific timing information. This EEPROM can be programmed with an external I<sup>2</sup>C programmer. If the programmer supports 3.3 V output voltage, the MB-COME6-2 can be programmed without any additional power supply. In this case no COM Express™ module should be connected to the carrier board.

#### X24: LVDS connector

- Connector type: Hirose DF19G-30P-1H
- Mating connector: Hirose DF19-30S-1C

Table 6: LVDS Connector X24

Pin	Signal	Remark
1	A0-	Odd bus
2	A0+	Odd bus
3	A1-	Odd bus
4	A1+	Odd bus
5	A2-	Odd bus
6	A2+	Odd bus
7	GND	-
8	ACLK-	Odd bus
9	ACLK+	Odd bus
10	A3-	Odd bus
11	A3+	Odd bus
12	B0-	Even bus
13	B0+	Even bus
14	GND	-
15	B1-	Even bus
16	B1+	Even bus
17	GND	-
18	B2-	Even bus
19	B2+	Even bus
20	BCLK-	Even bus
21	BCLK+	Even bus
22	B3-	Even bus
23	B3+	Even bus
24	GND	-
25	5V_PANEL	5 V Panel supply voltage
26	5V_PANEL	
27	5V_PANEL	
28	3V3_PANEL	3.3 V Panel supply voltage
29	3V3_PANEL	
30	3V3_PANEL	



Illustration 6: LVDS Connector X24

**X13: Backlight Power connector**

- Connector type: Phoenix MSTBA2,5/ 4-G-5,08
- Mating connector: Phoenix MSTBA2,5/ 4-ST-5,08

Table 7: Backlight Power Connector X13

Pin	Signal	Remark
1	12V_BL	12 V always-on output
2	VCC_IN <sup>1)</sup>	Backlight voltage input
3	GND	-
4	VCC_BLKT_OUT	Backlight voltage output

<sup>1)</sup> A voltage of up to 30 V can be supplied at this pin. Connect Pin 1 and 2 to use the 12 V of the MB-COME6-2 for the backlight.

**X25: Backlight connector**

- Connector type: Hirose DF19G-20P-1H
- Mating connector: Hirose DF19-20S-1C

Table 8: Backlight Connector X25

Pin	Signal	Remark
1	12V_BL	12 V always-on output
2	12V_BL	
3	12V_BL_SL	12 V switched output
4	12V_BL_SL	
5	GND	-
6		
7		
8	5V_BL	5 V always-on output
9	5V_BL	
10	5V_BL	
11	5V_BL_SL	5 V switched output
12	5V_BL_SL	
13	5V_BL_SL	
14	BLN	Backlight Enable output
15	BLT_CTRL	Backlight (brightness) control
16	GND	-
17	3V3_PROG <sup>1)</sup>	3.3 V input (programming)
18	EDID_CLK <sup>1)</sup>	EDID I <sup>2</sup> C clock
19	EDID_DAT <sup>1)</sup>	EDID I <sup>2</sup> C data
20	GND	-



Illustration 7: Backlight Connector X25

<sup>1)</sup> These pins can be used to program the on-board EDID EEPROM. The EEPROM can be powered by the 3V3\_PROG pin.

### 3.5.9 Mini PCIe Socket

The MB-COME6-2 provides a socket to support one full size Mini PCIe card. The signals of a USB and a PCIe x1 interface are connected to this socket. There is also a Micro SIM card socket for native support of UMTS or LTE Mini PCIe cards. A half size card can be inserted into this socket by means of a mechanical adapter. The reachable transfer rate of this interface depends mainly on the COM Express™ module used and the connected device.

### 3.5.10 M.2 Socket with E-Keying (for I/O devices)

The MB-COME6-2 provides a socket to support a M.2 module with 22 mm width and 30 mm length. The signals of a USB and a PCIe x1 interface are connected to this socket. M.2 2230 single and double sided modules with E or A+E-Keying can be inserted. The maximum transfer rate of this interface mainly depends on the COM Express™ module used and the connected device.

### 3.5.11 M.2 Socket with M-Keying (for SSD devices)

The MB-COME6-2 provides a socket to support a M.2 module with 22 mm width and 80 mm length. In the Standard Configuration only SATA-based M.2 SSDs are supported. The maximum transfer rate of this interface mainly depends on the COM Express™ module used and the connected device.

For the MB-COME6-2 there is a configuration possible, where PCIe- (up to PCIe x4) and SATA- based M.2 SSDs are supported. For this, the used COM Express™ module also has to support this feature.

Please contact [support@tq-group.com](mailto:support@tq-group.com) for further information about useable M.2 SSDs.

### 3.5.12 SATA Interfaces

The MB-COME6-2 supports up to 4 SATA interfaces:

- One connector for 2.5" HDD/SSDs, which can be mounted on the carrier board with a mounting set
- One socket for M.2 SSDs
- Up to 2 standard SATA connectors

The maximum transfer rates of these interfaces mainly depend on the COM Express™ module used and the connected devices.

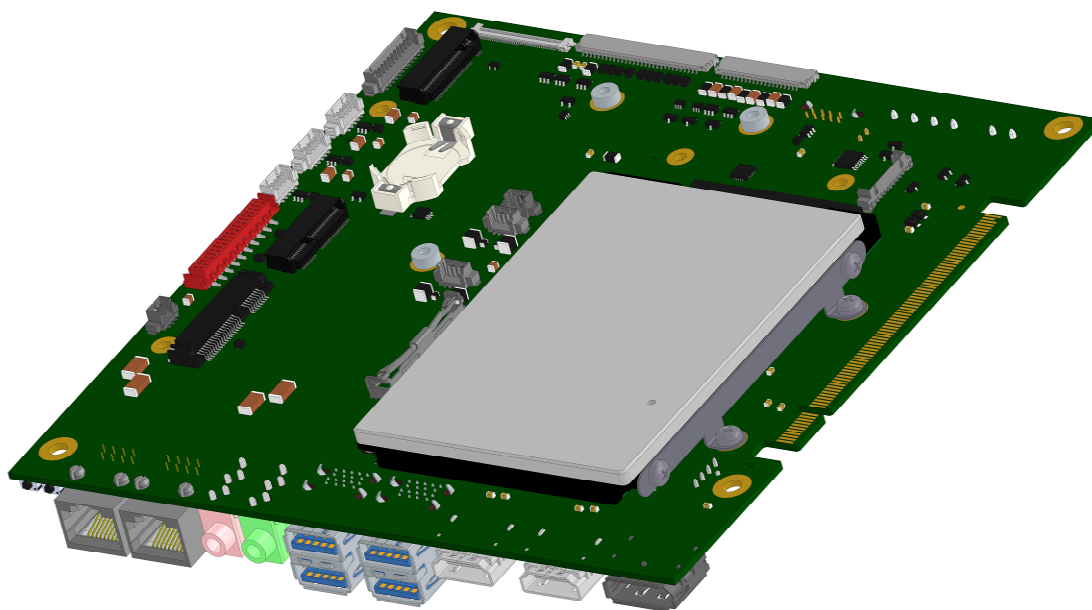

Illustration 8: 2.5" HDD/SSD Mounting

### 3.5.13 Audio

The MB-COME6-2 provides an audio codec and an audio amplifier to support following audio features:

- Headphone out
- Microphone in
- Speaker out (up to  $2 \times 1.4 \text{ W} @ 8 \Omega$  or  $2 \times 2.1 \text{ W} @ 4 \Omega$ )

X35: Speaker connector for right speaker

- Connector type: Molex 53261-0471
- Mating connector: Molex 51021-0400 crimp housing

Table 9: Speaker Connector for Right Speaker X35

Pin	Signal	Remark
1	SPK_OUT_R+	Speaker out right +
2		
3	SPK_OUT_R-	Speaker out right -
4		

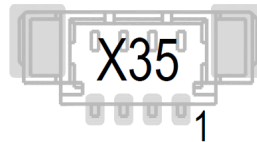

Illustration 9: Speaker Connector X35

X38: Speaker connector for left speaker

- Connector type: Molex 53261-0471
- Mating connector: Molex 51021-0400 crimp housing

Table 10: Speaker Connector for Left Speaker X38

Pin	Signal	Remark
1	SPK_OUT_L+	Speaker out left +
2		
3	SPK_OUT_L-	Speaker out left -
4		

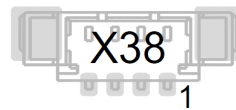

Illustration 10: Speaker Connector X38

### 3.5.14 Fan Connector

The MB-COME6-2 provides a connector for 12 V fans.

X22: 12 V fan connector

- Connector type: Molex 47053-1000
- Mating connector: 4-pin or 3-pin fan connector (2.54 mm pitch)

Table 11: 12 V Fan Connector X22

Pin	Signal	Remark
1	GND	-
2	12 V	-
3	SENSE	Sense input for fan speed
4	CONTROL	Speed control output

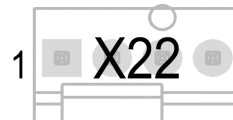

Illustration 11: 12 V Fan Connector X22

If a fan with 3 pin connector is connected, it may always run with full speed.

### 3.5.15 Riser Interface

The MB-COME6-2 provides a card edge connector. PCI or PCIe cards can be connected to this card edge connector with different adapters. For further information about the card edge connector, please contact TQ-Systems GmbH.

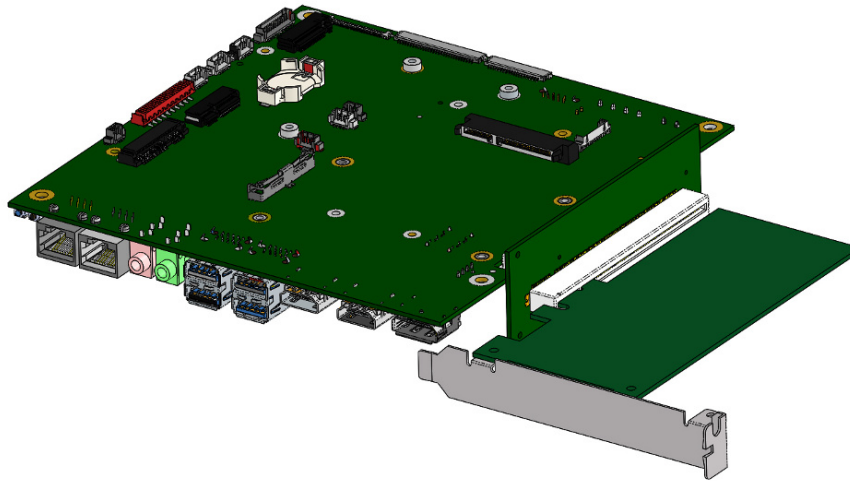

Illustration 12: PCIe card Installation Configuration

### 3.5.16 Power and Reset Button Connector

The MB-COME6-2 provides a connector to connect a power and a reset button.

Table 12: Power and Reset Button Connector X39

Pin	Signal	Remark
1	PWR_BTN#	–
2	GND	–
3	RST_BTN#	–

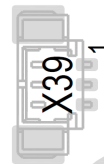

Illustration 13: PWR and RST Button X39

### 3.5.17 I<sup>2</sup>C and COME Connector

The MB-COME6-2 provides an optional connector, where the COME I<sup>2</sup>C, the SMBus and a few COM Express™ signals are available. This connector is for debug and software development purposes. The user can access to SMBus, I<sup>2</sup>C bus and a few other signals. This connector is not present on the MB-COME6-2 standard configuration.

Table 13: I<sup>2</sup>C and COME Connector X26

Pin	Signal	Remark
1	V_3V3#	3.3 V supply
2	SMB_CK	SM bus clock
3	SMB_DAT	SM bus data
4	SMB_ALERT#	SM bus alert
5	GND	–
6	I2C_CK	COM Express™ I <sup>2</sup> C bus clock
7	I2C_DAT	COM Express™ I <sup>2</sup> C bus data
8	THRMTRIP#	Thermal shutdown signal from module
9	SLEEP#	Sleep button signal to module
10	SATA_ACT#	SATA activity signal from module
11	WAKE1#	Wake up signal to module
12	SUS_S4#	Suspend to disk state signal

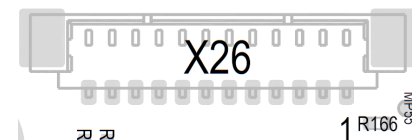

Illustration 14: 12 V Fan Connector X26



### 3.5.18 Debug LEDs

The MB-COME6-2 provides several LEDs for debug purposes.

Table 14: Debug LEDs

Function	PCB Text	Remark
Power	PWR	Green if 12 V input power is present
SUS S3	S3 act.	Green if module is in power-saving mode S3 (Suspend to RAM)
Power Good #	PWR GD#	Green if no PWR_OK signal is sent to module
Reset active	RST act.	Green if Reset is asserted
M.2 SSD active	M.2 SSD	Green if M.2 SSD is active
Safe Net Dongle	SND	Safe Net Dongle LED (green)

### 3.5.19 SPI Flash Socket

The MB-COME6-2 provides a socket for SPI flashes. This is useful if a BIOS update fails or for BIOS development purposes. SPI-Flashes with SO8W package can be inserted.

It depends on the COM Express™ module used whether a certain flash device is supported.

If the "BIOS\_DIS1#" jumper is set, the BIOS from the SPI flash in the socket is active.

### 3.5.20 COM Express™ Connector

The EPT 401-55101-51 or equivalent is used as COM Express™ connector.

The stack height (board to board distance between carrier board and module) is 8 mm.

## 4. MECHANICS

### 4.1 Dimensions

The dimensions are according to the Mini-ITX form factor, which is  $170 \times 170 \text{ mm}^2$ . The following illustration shows the dimensions of the MB-COME6-2.

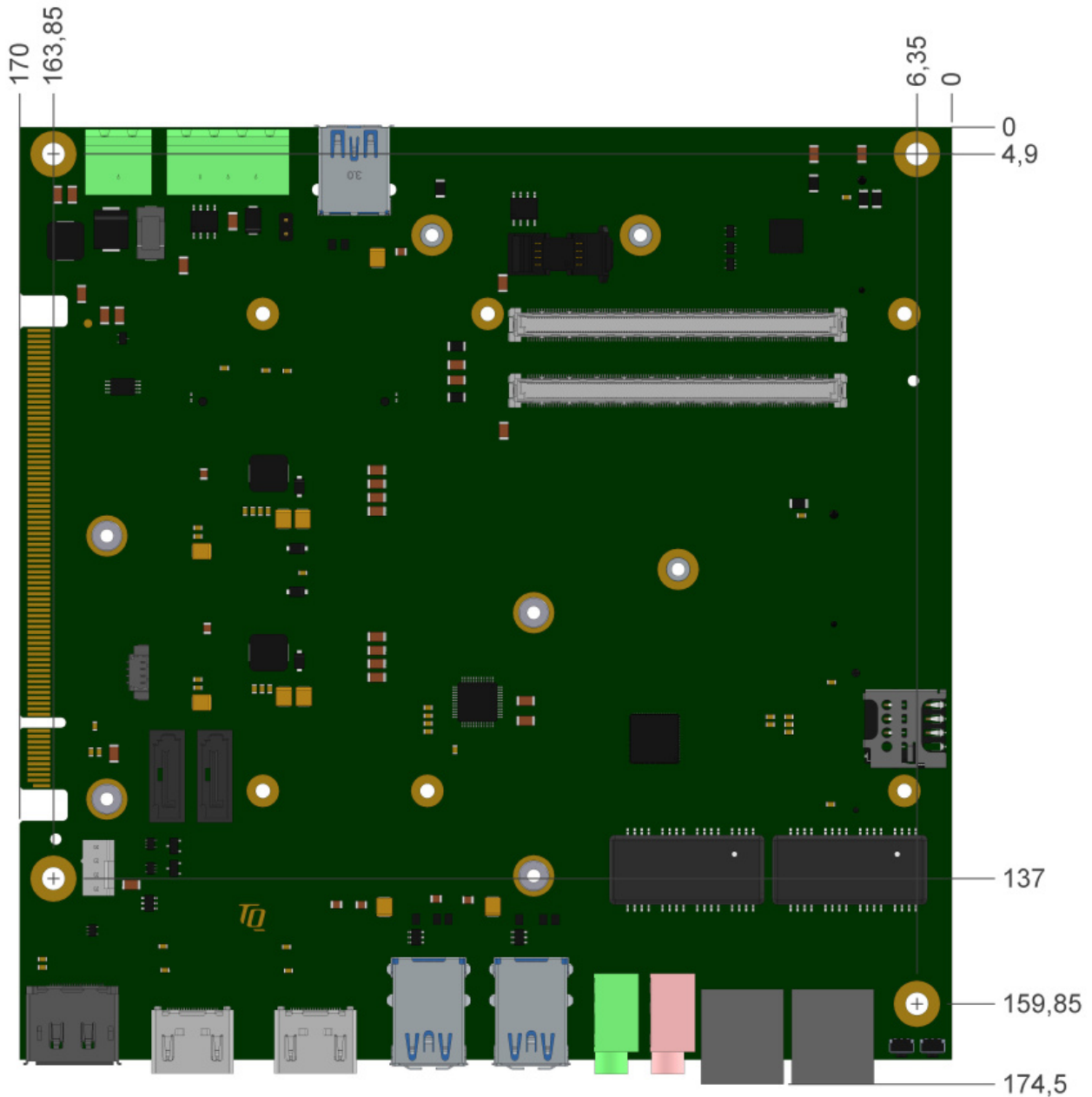

Illustration 15: MB-COME6-2 dimensions

Please contact [support@tq-group.com](mailto:support@tq-group.com) for more details about 2D/3D Step models.

### 4.2 Protection Against External Effects

The MB-COME6-2 is not protected against dust, external impact and contact (IP00). Adequate protection has to be guaranteed by the surrounding system.



## 5. SOFTWARE

### 5.1 System Resources

#### 5.1.1 I<sup>2</sup>C Bus

The general purpose I<sup>2</sup>C bus (COM Express™ pin names I2C\_DAT and I2C\_CK) is accessible on the I<sup>2</sup>C and COME connector. There are no I<sup>2</sup>C devices connected to this bus on the MB-COME6-2.

#### 5.1.2 SMBus

The SMBus (System Management Bus) on the MB-COME6-2 is routed to the PCIe clock buffer, the LM75A temperature sensor and to the card edge connector. It is also accessible at the I<sup>2</sup>C and COME connector.

The following table shows the I<sup>2</sup>C address mapping for the COM Express™ SMBus port:

Table 15: I<sup>2</sup>C Address Mapping COM Express™ SMBus Port

8-bit Address	Function	Device	Remark
0xC4	PCIe Clock buffer	Silicon Labs SI53106	–
0x90	Temperature sensor	NXP LM75A	Not present in standard version

### 5.2 Operating Systems

#### 5.2.1 Supported Operating Systems

The MB-COME6-2 supports various Operating Systems:

- Microsoft® Windows® 10
- Microsoft® Windows® 8.1 / Microsoft® Windows® Embedded Standard 8 (WES8)
- Microsoft® Windows® 7 / Microsoft® Windows® Embedded Standard 7 (WES7)
- Linux (i.e. Ubuntu 14.10 or later)

Other Operating Systems are supported on request.

Please contact [support@tq-group.com](mailto:support@tq-group.com) for further information about supported Operating Systems.

#### 5.2.2 Driver Download

The MB-COME6-2 module is well supported by the Standard Operating Systems, which already include most of the drivers required. It is recommended to use the latest drivers for optimal performance and the full feature set of the module.

Drivers for the Intel® i201IT Gigabit Ethernet controller can be downloaded at this Intel® page:

- Intel® Download Center: Intel® Ethernet Controller i210 Series  
<https://downloadcenter.intel.com/product/64399/Intel-Ethernet-Controller-I210-Series>

Please contact [support@tq-group.com](mailto:support@tq-group.com) for further driver download assistance.





## 6. SAFETY REQUIREMENTS AND PROTECTIVE REGULATIONS

### 6.1 EMC

The MB-COME6-2 was developed according to the requirements of electromagnetic compatibility (EMC). Depending on the target system, anti-interference measures may still be necessary to guarantee that the limits for the overall system including housing are met.

### 6.2 ESD

In order to avoid interspersions on the signal path from the input to the protection circuit in the system, the protection against electrostatic discharge should be arranged directly at the inputs of a system. Most external interfaces are protected using ESD protection diodes. Measurements for ESD protection have to be done with the electronic parts mounted in a housing. Since TQ-Systems GmbH does not offer a housing for the MB-COME6-2, no special preventive measures are taken.

### 6.3 Operational Safety and Personal Security

Due to the occurring voltages (12 V DC), tests with respect to the operational and personal safety have not been carried out.

### 6.4 Reliability and Service Life

#### 6.4.1 RoHS Compliance

The MB-COME6-2 is manufactured RoHS compliant.

- All components and assemblies used are RoHS compliant
- RoHS compliant soldering processes are used

#### 6.4.2 WEEE Regulation

The company placing the product on the market is responsible for the observance of the WEEE regulation. To be able to reuse the product, it is produced in such a way (a modular construction) that it can be easily repaired and disassembled.

### 6.5 Other Entries

By environmentally friendly processes, production equipment and products, we contribute to the protection of our environment.

The energy consumption of this subassembly is minimised by suitable measures.

Printed PC-boards are delivered in reusable packaging.

Modules and devices are delivered in an outer packaging of paper, cardboard or other recyclable material.

Due to the fact that at the moment there is still no technical equivalent alternative for printed circuit boards with bromine-containing flame protection (FR-4 material), such printed circuit boards are still used.

No use of PCB containing capacitors and transformers (polychlorinated biphenyls).

These points are an essential part of the following laws:

- The law to encourage the circular flow economy and assurance of the environmentally acceptable removal of waste as at 27.9.94 (source of information: BGBl I 1994, 2705)
- Regulation with respect to the utilization and proof of removal as at 1.9.96 (source of information: BGBl I 1996, 1382, (1997, 2860)
- Regulation with respect to the avoidance and utilization of packaging waste as at 21.8.98 (source of information: BGBl I 1998, 2379)
- Regulation with respect to the European Waste Directory as at 1.12.01 (source of information: BGBl I 2001, 3379)

This information is to be seen as notes. Tests or certifications were not carried out in this respect.



## 7. APPENDIX

### 7.1 Acronyms and Definitions

The following acronyms and abbreviations are used in this document.

Table 16: Acronyms

Acronym	Meaning
ATA	Advanced Technology Attachment
BIOS	Basic Input/Output System
DP	Display Port
DVI	Digital Visual Interface
EDID	Extended Display Identification Data
eDP	embedded DisplayPort
EEPROM	Electrically Erasable Programmable Read-Only Memory
EMC	Electromagnetic Compatibility
ESD	Electrostatic Discharge
FAE	Field Application Engineer
flexiCFG	Flexible Configuration
FR-4	Flame Retardant 4
HD	High Definition (Audio)
HDD	Hard Disk Drive
HDMI	High Definition Multimedia Interface
HPD	Hot Plug Detect
I/O	Input/Output
I <sup>2</sup> C	Inter-Integrated Circuit
IEEE®	Institute of Electrical and Electronics Engineers
IP	Ingress Protection
LED	Light Emitting Diode
LTE	Long Term Evolution
LVDS	Low Voltage Differential Signal
MOOP	Means Of Operator Protection
NC	Not Connected
PC	Personal Computer
PCB	Printed Circuit Board
PCI	Peripheral Component Interconnect
PCIe	Peripheral Component Interconnect express
PCMCIA	People Can't Memorize Computer Industry Acronyms
PICMG®	PCI Industrial Computer Manufacturers Group
RAM	Random Access Memory
RMA	Return Merchandise Authorization
RoHS	Restriction of (the use of certain) Hazardous Substances
RS-232	Recommended Standard (serial interface)
SATA	Serial ATA
SIM	Subscriber Identity Module
SMB	System Management Bus
SPI	Serial Peripheral Interface
SSD	Solid-State Drive
UEFI	Unified Extensible Firmware Interface
UMTS	Universal Mobile Telecommunications System
USB	Universal Serial Bus
VGA	Video Graphics Array (640 × 480)
WEEE®	Waste Electrical and Electronic Equipment
WES	Microsoft® Windows® Embedded Standard
WLAN	Wireless Local Area Network



## 7.2 References

Table 17: Further Applicable Documents and Links

No.	Name	Rev. / Date	Company
(1)	PICMG® COM0 COM Express™ Module Base Specification	Rev. 2.1 / May 14, 2014	<a href="#">PICMG®</a>
(2)	PICMG® COM Express™ Carrier Design Guide (available for public download) <a href="https://www.picmg.org/wp-content/uploads/PICMG_COMDG_2.0-RELEASED-2013-12-061.pdf">https://www.picmg.org/wp-content/uploads/PICMG_COMDG_2.0-RELEASED-2013-12-061.pdf</a>	Rev. 2.0 / Dec. 6, 2013	<a href="#">PICMG®</a>
(3)	Intel® Download Center: Intel® Ethernet Controller i210 Series <a href="https://downloadcenter.intel.com/product/64399/Intel-Ethernet-Controller-I210-Series">https://downloadcenter.intel.com/product/64399/Intel-Ethernet-Controller-I210-Series</a>		<a href="#">Intel®</a>



