



KTX2

Mode-S Transponder

Standard



Part No 286043= KRT2-S (Standard)

User and Installation Manual



Revision List

Revision	Date	Topic
0100	24.03.2017	Initial Release
0101	20.02.2018	Amendments for extended Squitter and maintenance

Service Bulletins (SB)

Service Bulletins must be inserted in the manual and added to this table.

No SB	No Rev.	Release date	Date Added	Name



Change History

Product Revision	Date	Description of Change
0200	24 Mar 2017	Base Version
0201	20 Feb 2018	Additional instructions for use of ADS-B out (extended squitter). Chap. 7 (maintenance) amended



Table of Contents

Revision List.....	2
Service Bulletins (SB)	2
Change History	3
List of Figures	5
1. General	6
1.1. Symbols	6
1.2. Abbreviations	7
1.3. Customer Support.....	8
1.4. Features.....	9
2. Operation	10
2.1. Controls.....	10
2.1.1. Keys.....	11
2.1.2. Values.....	12
2.2. ON/OFF	13
2.3. Display brightness.....	14
2.4. Transponder-Modes.....	14
2.5. Squawk-Setting.....	15
2.6. VFR – Squawk	15
2.7. Squawk Ident (ID, SPI).....	16
2.8. Flight/Ground Indication	16
2.9. Flight-ID (FID) & Set-Up.....	17
2.9.1. General	17
2.9.2. Entering Set Up.....	17
2.9.3. Set Flight-Identifer (FID)	19
2.9.4. Supplemental indication	20
2.9.4.1. Mode A/C/S	20
2.9.4.2. Extended Squitter	20
2.9.5. Set-Up.....	21
2.9.5.1. Aircraft Address (AA).....	21
2.9.5.2. Aircraft Category	22
2.9.5.3. Ground Switch	22
2.9.5.4. Speed Category.....	23
2.9.5.5. Interface.....	23
2.9.5.6. Multiple Use	24
2.9.5.7. Use of multiple aircraft.....	25
2.10. Operation with multiple registrations	26



3.	Self-Test (Errors)	27
3.1.	Setup Error.....	27
3.2.	External Warnings/Errors	28
3.2.1.	General Control.....	28
3.3.	Fatal Errors	29
4.	Installation.....	30
4.1.	Equipment Connections	30
4.1.1.	Electrical Connections	30
4.1.2.	Mutual Suppression	30
4.1.3.	Ground Switch	31
4.1.4.	Static Air Port.....	31
4.1.5.	Interface.....	31
4.2.	Wiring.....	32
4.2.1.	Conductor Cross Section	32
5.	Drawings	33
5.1.	KTX2-S	33
6.	Technical Data	34
6.1.	General	34
6.2.	Transmitter - Receiver.....	35
7.	Maintenance	36
7.1.	Periodic Maintenance.....	36
7.2.	Repair	36
7.3.	Cleaning.....	36



List of Figures

Figure 1:	Display Diagram.....	10
Figure 2:	Controls	11
Figure 3:	Indicators	12
Figure 4:	Extended Squitter	20
Figure 5:	Interface.....	23
Figure 6:	Warnings.....	28
Figure 7:	Wiring.....	32
Figure 8:	Dimensions	33
Figure 9:	Technical Data	34
Figure 10:	Transmitter receiver	35

1. General

This manual contains information about the physical, mechanical and electrical characteristics, installation and operation of the Mode S Transponder KTX2.

1.1. Symbols

	<p>DANGER:</p> <p>Advices whose non-observance can cause radiation damage to the human body or ignition of combustible materials.</p>
	<p>ATTENTION:</p> <p>Advices whose non-observance can cause damage to the device or other parts of the equipment. or reduce the correct functionality of the device.</p>
	<p>INFORMATION</p>



1.2. Abbreviations

Abb.	Meaning	Explanation
FID	Flight ID	Flight plan Number or if not assigned Registration Number of aircraft
SPI	Special Position Identification	Activation on request by controllers „Squawk Ident“, transmits SPI Pulse for 18 seconds, which highlights the respective traffic item on the controllers radar screen
AA	Aircraft Address	Assigned ICAO 24 bit address
AC	Aircraft Category	Defines aircraft type into specific categories
RI	Reply Information	Classified air speed



1.3. Customer Support

In order to facilitate a rapid handling of returned shipments, please send your request at the email address below. Additional information and FAX number can be found on the TQ Avionics web portal:

www.tq-avionics.com



Any suggestions for improvement of our manuals are welcome. Contact: info@tq-avionics.com



Information on software updates are available at TQ.
www.tq-avionics.com

1.4. Features



In order to operate the Mode-S transponder it is necessary to request (in time) an ICAO 24-Bit Aircraft Address at the responsible National Aviation Authorities. The received code must be configured within the transponder (see chapter. 2.9 “Flight-ID (FID) & Set-Up”).

- Class 1 Level 2els Non-Diversity Mode-S-Transponder for ground based interrogations at 1030 MHz and response at 1090 MHz
- Replies to (Secondary) Radar Interrogations
 - Mode-A replies with a Squawk (one of 4096 possible Codes; e.g. flight plan number, Squawk assigned by a Controller or the VFR Squawk 7000).
 - Mode C replies, including Encoded Flight Level.
 - Mode S replies, including Aircraft Address and Flight Level.
 - Event Squitter, containing Identification Information.
 - Extended Squitter, including position data.
- IDENT capability for activating the Special Position Identification“- Pulse (SPI) for 18 seconds, which is requested by the Controller „Squawk Ident“
- Maximum flight level 30 000ft; maximum airspeed 250kt
- Display information contains Squawk code, mode of operation and pressure altitude.
- Temperature compensated high precision piezo-resistive pressure sensor
- RS-232 data port enabling connection with mutual suppression and On the Ground (weight on wheels) inputs. In addition, an appropriate GPS receiver for “extended squitter” can be connected.
- 8 storable entries for AA-/AC-Code, FID, Ground-Switch, RI-Code.

2. Operation

2.1. Controls

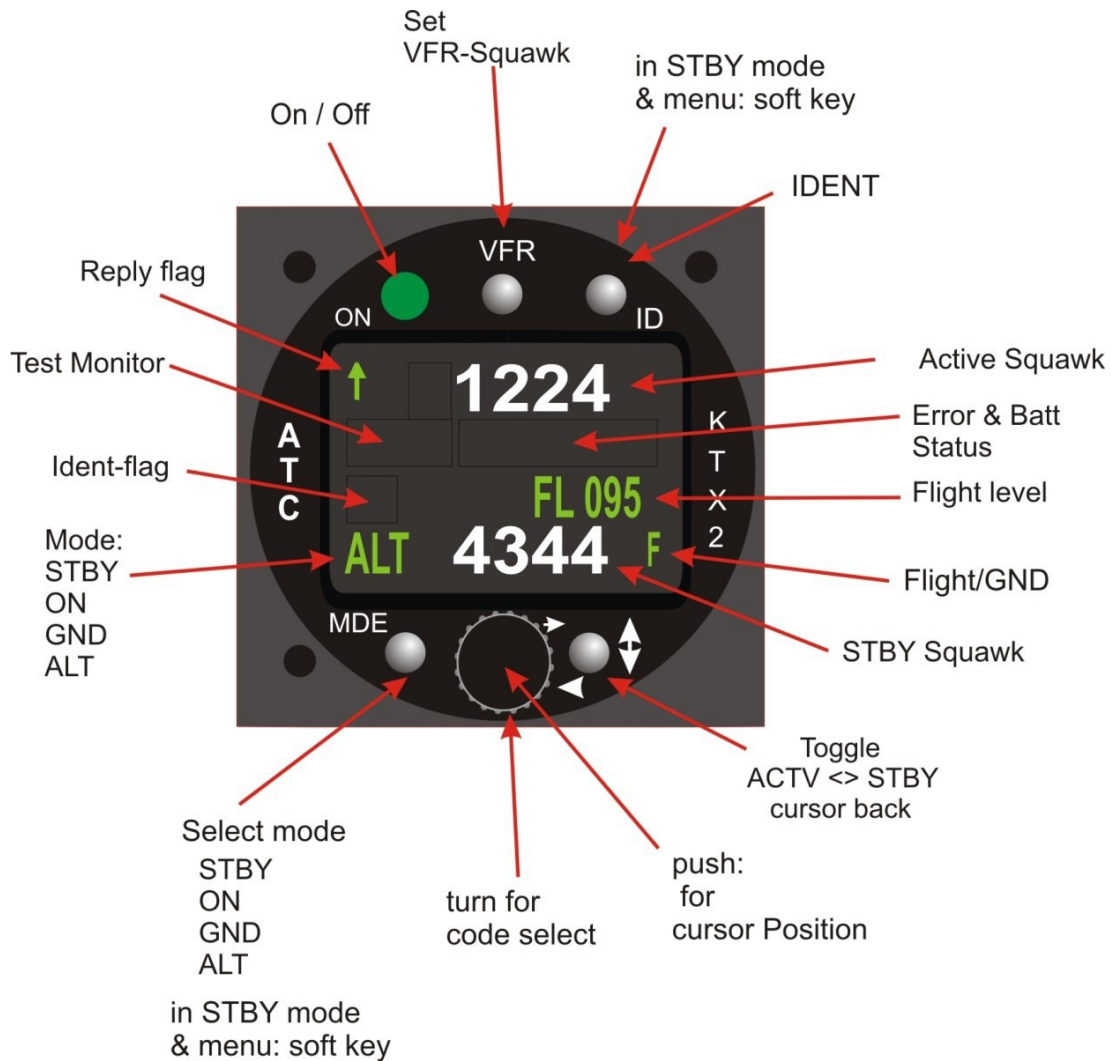

Figure 1: Display Diagram

2.1.1. Keys







Key	Designation	Function
	ON/OFF	Push = ON. This switch is mechanically locked until it is pushed a second time.
	VFR	Activate/deactivate VFR Squawk (press shortly) Store the standby Squawk as VFR/VFRW-Squawk (press button 3 s) see chapter “2.6 VFR – Squawk”.
	CHANGE	1. Exchange of the active and standby-Squawk 2. Works as cursor back button when entering values and also for navigating backwards through the configuration menu (see chapter “2.5 Squawk-Setting”).
	IDENT	„Squawk Ident“, sends Ident marking (SPI) for 18s (in normal mode) see chapter. “2.9 Flight-ID (FID) & Set-Up”
	MODE	Select Transponder-Mode ACS, A-S or Standby (see chapter “2.4 Transponder- Modes”)
	Rotary knob	Enter values at current cursor position, select options; set standby Squawk

Figure 2: Controls

2.1.2. Values





Indication	Meaning	Remark
	Transponder is transmitting Mode-A/C Replies on Interrogations	Appears per reply
	Transponder is transmitting Mode-S Replies on Interrogations	Appears per reply
	Transponder is locked by a ground station and will be directly addressed	Appears at every addressed reply
	Extended Squitter	see chapter 2.9.4.2 Extended Squitter
1224	Active Squawk	
BAT	Battery power too low	Blinking
ID	Transmits IDENT- Marking	ID („Squawk Ident“) has been pressed – active for 18s
FL010	Flight Level	Flight Level (in 100ft steps)
ALT	Mode display (STBY, ON, GND, ALT)	see chapter. 2.4 Transponder-Modes
4344	Standby-Squawk	Can be changed with active Squawk by pressing the UP/DOWN button

Figure 3: Indicators

2.2. ON/OFF

The device is switched on/off by pressing the mechanically locked key.

After power up the display appears as follows (Example):



Device Name

KTX2

Software-Version
 e.g. V.0101

Firmware-Version
 e.g. FPGA: 6.0
 (displays 2 sec later)

After app. 8 seconds the normal operation window appears and the transponder will enter the mode ALT. If a weight on wheels switch is installed and the aircraft is on ground the mode GND will be set.



No GND switch installed



GND-switch installed, on GND

2.3. Display brightness

Push the MDE button until STBY is indicated then Push the ID button for 2 sec.

In the upper right corner the display shows DIM x. Change the setting with the rotary knob. Return to normal operation is automatic.



2.4. Transponder-Modes

The active mode is displayed at the bottom left corner.



STBY	Transponder is on but does not respond to any interrogation.
GND	Transponder responds to Mode-S interrogations.
ON	Transponder responds to all interrogations, only altitude is not transmitted.
ALT	Transponder responds to all interrogations.

During the flight the Mode ALT should always be set, unless the controller gives other instructions.

While rolling on the ground the transponder should be set to GND, unless the installation includes a weight on wheels switch. In this case, the mode changes automatically.

The Mode-selection is done by repeatedly pressing the MDE button.

To enable or disable the Extended Squitter, press the MDE button for approximately 2 seconds.

2.5. Squawk-Setting

The active Squawk is displayed on the top, the Standby-Squawk is shown and changed below.



Setting of the Standby-Squawks:

- Setting the Squawk is done by rotating and pushing the rotary knob. Pushing the rotary knob repeatedly highlights the character to be changed.
- The UP/DOWN button exchanges of the Active and the Standby Squawk when in the normal mode. The left arrow indicates navigating backwards when in any menu.

2.6. VFR – Squawk

The factory setting of the VFR transponder code is 7000. The VFR transponder code however can be user defined.

- To activate the VFR-Squawk push the VFR button. VFR is then indicated on the display.





- When VFR is displayed a user defined VFR transponder code can be selected in the standby window by pushing and turning the rotary knob.
- In order to store this new VFR transponder code, push and hold the VFR button until “S” is indicated on the display after approximately 3 seconds.

Therefore the input-mode must not be active (no share signs) and the VFR mark below the active code must not be displayed.

2.7. Squawk Ident (ID, SPI)

On request of the radar controller push the ID button when not in the STBY mode. Transmission of the ID signal will last for 18 seconds and is displayed above the mode.

2.8. Flight/Ground Indication

Aircrafts with AIR/GROUND switches display “F” (Flight) or “G” (Ground) in the lower right corner.

This function must be activated in the set up procedure.

When this function is not activated, there are no indications on the display and modes must be manually selected.

2.9. Flight-ID (FID) & Set-Up

2.9.1. General

ICAO regulations require Mode-S data to contain a valid flight identification (FID), to ensure automatic exchange of flight plan and radar data.

There are 3 types of FIDs

- Aircraft identification as specified in item 7 of the ICAO flight plan.
- Company flight plan e.g. KLM511, BAW213, LH400
- Aircraft registration e.g. DEABC, FPQUM

FID entries must be left aligned and may not contain any dashes, spaces, blanks or zeros. Not used remaining right digits must be blank.

2.9.2. Entering Set Up

Flight-ID or Set-Up changes can only be done when in the STBY mode. Push the MDE button repeatedly until “STBY” appears, Push and hold the ID button.

- “DIM x” (for dimming) appears from 0 to 5 seconds
- “setFID” (for setting of flight ID) appears from 5 to 8 seconds
- “SetUP” (for the Set up menu) appears after 8 seconds

Just release the ID button when the appropriate menu is displayed.



Menus will be active for 10 seconds. When there is no input within 10 seconds the respective menu is left automatically.

KTX2 setup menu initial display



The ID and MDE buttons are used as soft keys in these menus. Their function is displayed by symbols or text next to the respective buttons.

“skip“ or “OK” means advance to the next menu item.

“->“ (= next) means move cursor one position to the right.

2.9.3. Set Flight-Identifier (FID)

The FID is required for Mode-S Operation. Commercial flights usually have their own FIDs. General aviation FIDs should be the registration letters or numbers of the aircraft. The FID must not be confused with the 24-bit Aircraft Address. The six left letter/digits are the 24 bit address (AA) and the next two is the aircraft category (AC). The FID is left aligned and shown in white characters. The FID may not contain blanks however the non-used most right characters must be blank. The FID must start with the nationality code. If the first left sign is a blank the whole AA-setup will be deactivated.

Skip the button next “skip” will leave the menu without any changes.



Only the FID can be changed in this menu.

“^” marks the cursor position.

Pushing the ID button (skip) cancels the input.
 Pushing the MDE button (OK) saves the FID and the menu will be terminated automatically after 10 seconds.

	<p>Enter FID left-aligned, without any blanks or dashes (!), e.g. 3FEBA11CDMNWS for the marking D-MNWS. The last remaining digits shall be filled with blanks.</p>
---	---

	<p>FID containing blanks characters are invalid. Missing FID disables mode-S operation and A/C-mode only will be engaged. See chapter “3 Self-Test (Errors)”</p>
---	--

2.9.4. Supplemental indication

2.9.4.1. Mode A/C/S

Using the reply some additional useful indications are provided:

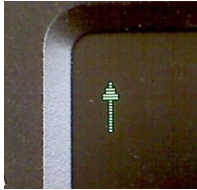

The Small arrow indicates mode-A/C reply.



The Wide arrow indicates mode-S reply.



A dot at the left side is for an addressed interrogation which indicates that the transponder is known in the radar system.

2.9.4.2. Extended Squitter





Indication	Function	Description
	Extended Squitter on	Transmitting data (including position data)
	Extended Squitter on	Transmitting data
	Extended Squitter on	No transmitting data
	Extended Squitter off	No transmitting data

Figure 4: Extended Squitter

2.9.5. Set-Up

2.9.5.1. Aircraft Address (AA)

When in the STBY mode, push and hold the ID button until “setup” appears.



This screen is the start menu for all further settings. Only the first 8 characters (in green) of the Aircraft Address (AA) can be changed (In hexadecimal digits [0..F]).

Pushing the MDE button will save the present settings.

2.9.5.2. Aircraft Category

In the next screen the airplane category can be set, after a short time the submenu comes up in sequence:



With the rotary knob one of 6 different vehicles classes can be selected.

- FixW<=5.7t = Airplane until 5.7t and speed <= 250kts
- GlidrSail = Glider
- GasFilled = Balloons
- ParaShutr = Parachutes
- ULM/HgPar = Ultra-light, Paraglider
- UAV = unmanned air vehicles

To save the selected Aircraft Category push the MDE button.

Note: The KTX2 is not yet certified for A/C FixW>7.5t, speed >250kts, helicopters (RotorCr). Therefore, these items are not selectable.

2.9.5.3. Ground Switch

Then the next submenu is asking for the AIR/GND switch function. YES/NO can be selected with the rotary knob.

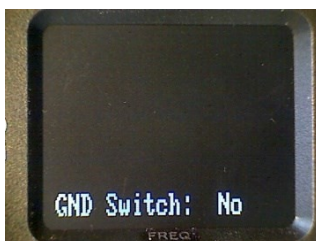

To save the AIR/GND function push the MDE button.

2.9.5.4. Speed Category

Then the next submenu is asking for the typical cruising speed.



The typical cruising speed can be selected with the rotary knob.

To save the typical cruising speed, push the MDE button.

2.9.5.5. Interface

The function can be selected with the rotary knob.

Indication	Function	Description
None	Extended Squitter off	Serial interface off
GPS 4800	Extended Squitter on	GPS receiver 4800 Baud
GPS 9600	Extended Squitter on	GPS receiver 9600 Baud
GPS 38400	Extended Squitter on	GPS receiver 38400 Baud

Figure 5: Interface

If Extended Squitter is on the AIR/GND function is not available.

If Extended Squitter is enabled or disabled, switch off the transponder and switch it on again to select the desired function.

2.9.5.6. Multiple Use

The next menu requires a decision to be made, whether to continue the Set-Up procedure, or to terminate the Set-Up.

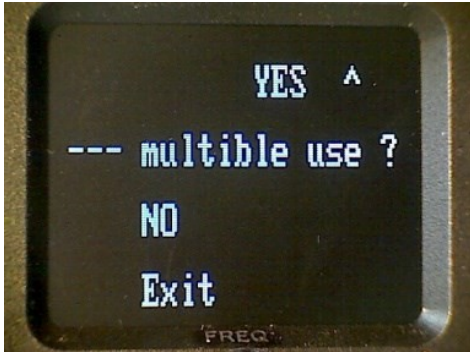

For a single permanently installed application the Set-Up procedure is complete and will be terminated after pushing the MDE button (EXIT).

----- End of normal Set Up -----

When the transponder is to be used on different vehicles, push the MDE button (YES) and continue with the next chapter “2.9.5.6 Use of multiple aircraft”.

2.9.5.7. Use of multiple aircraft

When the transponder is to be used for more than one aircraft (e.g. balloons) it is possible to enter up to 8 call signs. In this case every time the transponder is switched on the respective call sign must be selected.

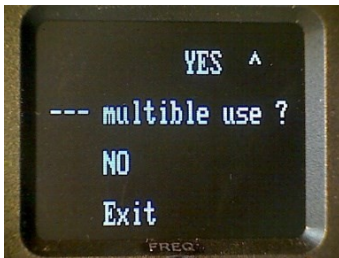

When this page is displayed, continue to input other aircraft data by pushing the ID button (YES).

The next submenu is displayed.



Select a free position with the rotary knob and enter the next call sign. Push the MDE button. Then the procedure as described in chapter “2.9.5 Set-Up” has to be applied for every call sign in the list.

The right page above shows a list of two different call signs, respectively aircraft, on which the transponder can be used. Up to 8 call signs can be stored.

Delete an entry:

To delete an entry it is sufficient to delete the first letter of the call sign. It is however recommended to delete the whole call sign

2.10. Operation with multiple registrations

If there is more than 1 call sign stored, a list of up to 8 possible call sign will appear when the transponder is switched on.



Select the appropriate call sign with the rotary knob and confirm with the MODE button.



After 3 seconds the KTX2 resumes normal operation.

3. Self-Test (Errors)

The KTX2 distinguishes 3 types of anomalies:

- Warnings
- Setup Errors
- Elementary Function Errors

3.1. Setup Error

If no FID-Code (Flight Identification) is entered or if the first or second letter of the FID 8 characters string is a blank, the following displays will appear after switching on the transponder:

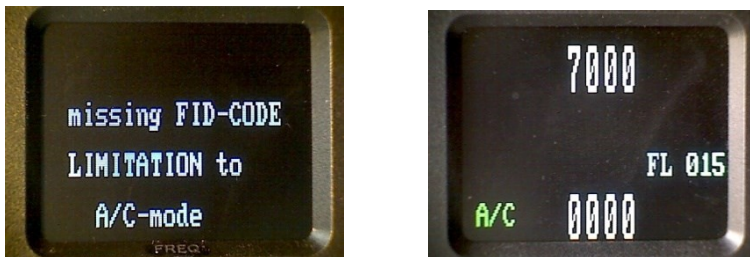

In this case transponder operation is limited to the A/C mode.

Available modes:

- A/C = normal operation,
- A-- = no height feedback
- STBY = operation on ground

3.2. External Warnings/Errors

The warning “BAT” blinking indicates a power supply voltage < 11V.



The transponder is designed to operate above 9volts. Do not operate the unit under 9volts.

3.2.1. General Control

The antenna adjustment as well as the transmission power, are surveyed, the results are displayed above the flight level display (blinking).



Meaning of the following displays

- ANT : Bad antenna adaption.
- ANTx : Antenna failed.
- TRX : Weak transmission.
- TRXx : Transmitter probably failed.
- DC : Low Power Voltage
- FPG: : Internal transfer

Figure 6: Warnings

3.3. Fatal Errors

This kind of error is only produced by a severe malfunction of the device. It also can be caused by power interruptions during power up of the transponder.

If the message cannot be removed by switching the transponder on and off repeatedly, it must be serviced.



System error, after unsuccessful restart –Service

ERROR stop types:

- Er_FPGA System error, after unsuccessful restart –Service
- Er-ADC System error, after unsuccessful restart –Service
- Memory System error, after unsuccessful restart –Service
in this case the KTX2 tries to go on with A/C-mode.
- Er-CRC Flash System error–Service

In order to be serviced, the defective part needs to be shipped to:

TQ-Systems GmbH
Gut Delling / Mühlstr. 2
82229 Seefeld
Germany



4. Installation

4.1. Equipment Connections

4.1.1. Electrical Connections

One 15pin D-SUB miniature connector includes all electrical connections, except for the antenna.

The (+UB)-wire has to be protected by Trip-Free circuit breaker (3 Amp.)!

4.1.2. Mutual Suppression

Other equipment on board (e.g. DME) may transmit in the same frequency band as the transponder.

If such a device is installed a single wire bus (Suppression = active at +12V) shall be installed in order to protect the receiving parts of the different devices from in-band transmissions.

Mutual suppression is a pulse that is sent to the other equipment to suppress transmission of a competing transmitter for the duration of the pulse train transmission. The transponder transmission may be suppressed by an external source and vice versa.

To activate mutual suppression the SUPP_I/O requires a +12V source from the other equipment.

Note:

All equipment connected to the suppression line must be re-inspected and reapproved before operation from a qualified avionic technician. Use shielded line.



4.1.3. Ground Switch

If a Ground-Switch is connected (and activated in the Setup), the transponder is enabled to distinguish between weight-on-wheel (On the Ground) and (In-Flight) conditions. In the weight-on-wheel condition the transponder automatically enters the Standby mode.

In order to complete this installation the input “FLY-GND” must be connected to a switch, which connects the input with “GND” in case there is weight on wheels, or remains open during flight.

This option must additionally be activated in the Setup. For details on configuration please refer to section 2.9.5.3 Set Up.

4.1.4. Static Air Port

Install a silicon soft tube fitting the 5 mm static air-port at the backside of the transponder and secure plumbing with appropriate clamps.

4.1.5. Interface

A GPS source can be connected to the serial interface (RS232) providing GPS position data (Extended Squitter).

Requirements:

- Software Revision 0101 and higher
- Required data format of the GPS hardware: Standard NMEA0183 RMC data stream including the RMC-sub-format (4800/9600/38400 Baud).
- GPS hardware needs to be connected to pins 2 and 13. Power supply needs to be provided separately considering the required operating voltage for the GPS hardware.

4.2. Wiring

4.2.1. Conductor Cross Section

Power Supply (Power, GND): AWG20 (0,62 mm²)
 Signals: AWG22 (0,38 mm²)

The conductors must be approved for aircraft use.

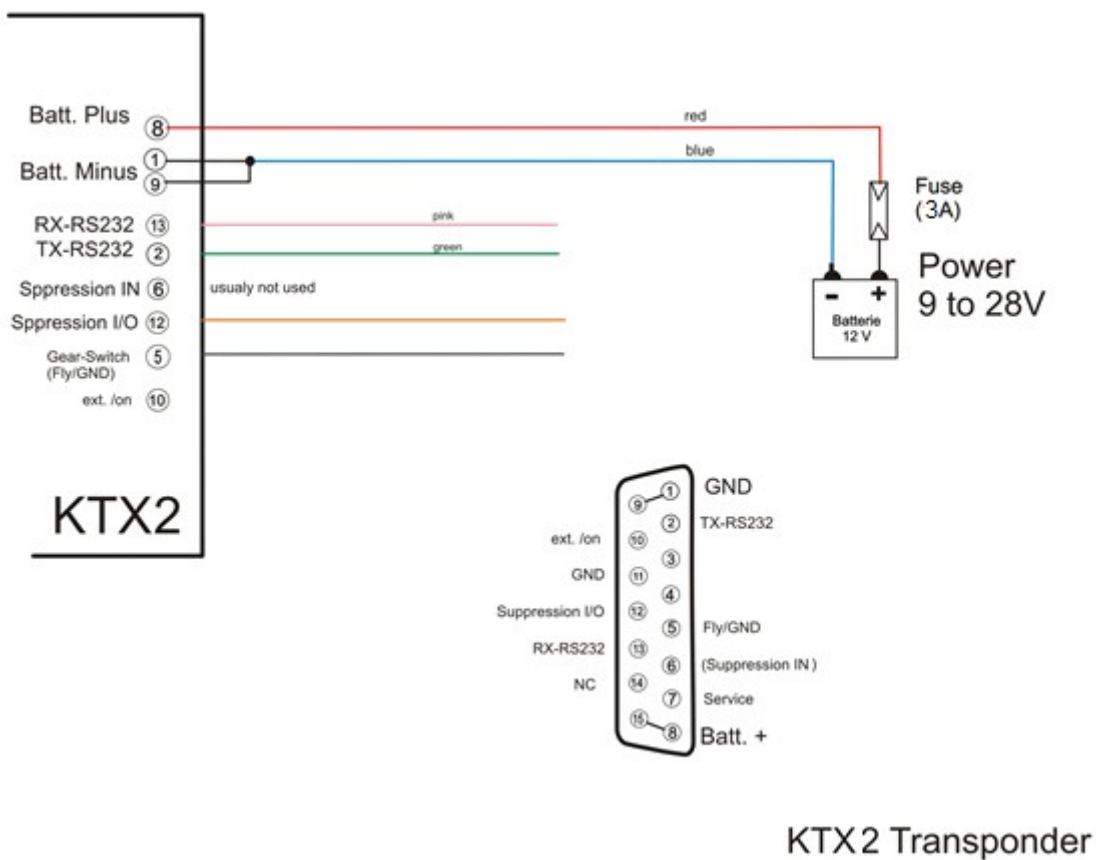

Figure 7: Wiring

5. Drawings

5.1. KTX2-S

Standard version Ø57 mm dimensions

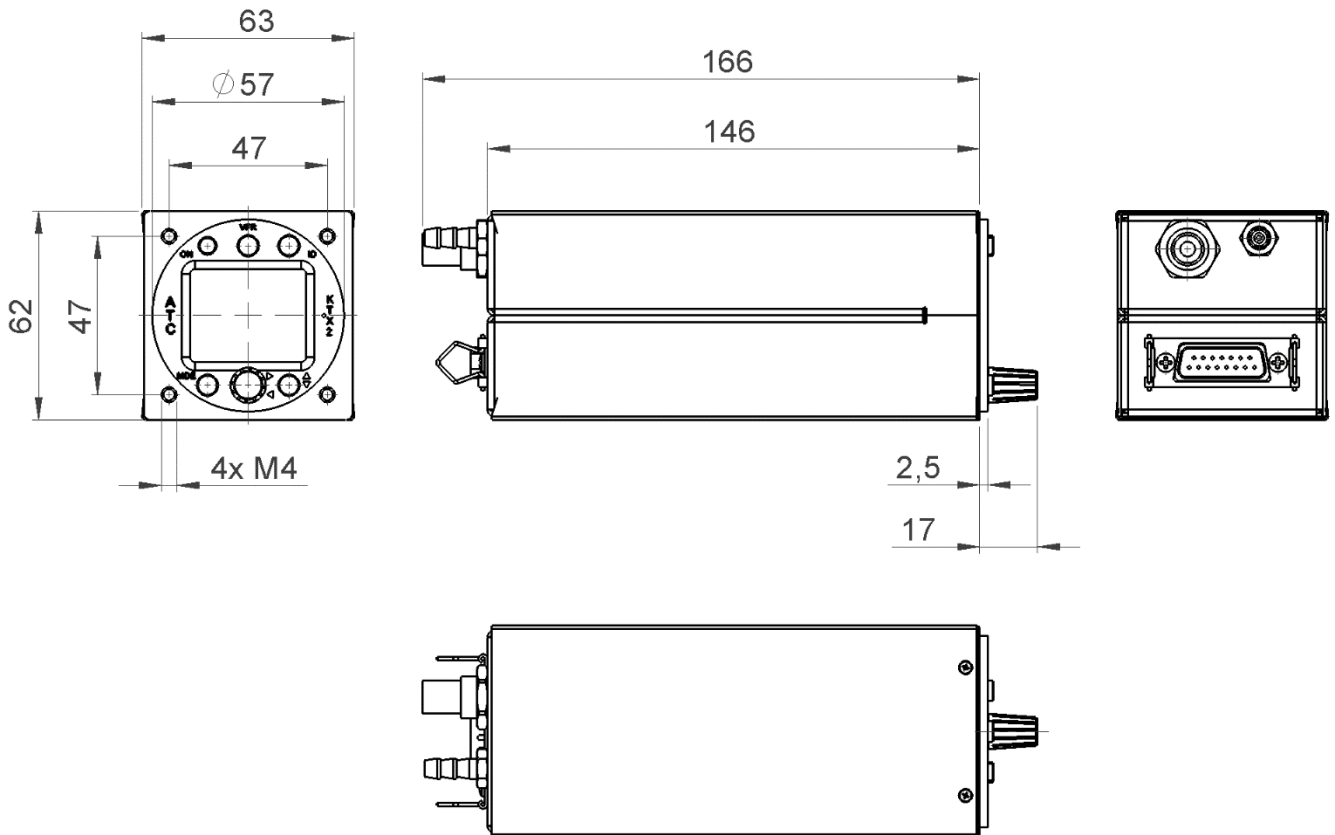

Figure 8: Dimensions



6. Technical Data

6.1. General

Designation	
Authorisation	EASA.21O.10062647
Standards	ED-73E/DO181E Level 2els, Class 1 ETSO-C112d ETSO88a
Applied Standards	RTCA DO-178C/ED-12C Level D RTCA DO-254/ED80 Level C RTCA DO-160F/ED-14F SAE AS8003
Dimensions KTX2	See drawings
Weight	KTX2= approx. 0.37 kg
Mounting	KTX2: cut-out Ø 57 mm
Temperature ranges: Operation Storage	-20 °C to +55 °C -55 °C to +85 °C
MAX. flight level	30 000ft
Vibration	DO-160F, Cat. S, Vibration Curve M
Humidity	RTCA DO-160F, Cat. A
Shock	6G operation 20G crash safety
RTCA DO-160F ENV. CAT.	[C4Z]CAB[SM]XXXXXXZ[BXX]AB[AC]YM[B2F2]XXAX
Power supply Power consumption	9 VDC to 33VDC test @ 12VDC <ul style="list-style-type: none">depending on the no. of requests 0.2 to 1.0AIllumination 0.02A emergency operation: 9 VDC
Fuse	External fuse required: 3A, slow-blow
Compass security distance	30cm

Figure 9: Technical Data



6.2. Transmitter - Receiver

TRANSMITTER	
Receiver Characteristics: Sensitivity	RF input power level resulting in a 90 % reply rate: <ul style="list-style-type: none">■ MTL for ATCRBS and ATCRBS/Mode S All-Call interrogations: -74dBm \pm3dB.■ MTL for Mode S interrogations: -74dBm \pm 3dB.
Reply transmission frequency	1090 \pm 1MHz
RF Peak Power Output	\geq 24dBW (250 W) at antenna base (with maximum cable attenuation of 1,5dB)
Squitter	Transmitted at random intervals uniformly distributed over the range from 0.8 to 1.2 seconds, full self-verification of data and occurrence

RECEIVER	
ICAO 24-bit Aircraft Address (Hex-Code)	Aircraft Address as assigned by National Aviation Authority
FID Capability Report	Flight ID: Flight Plan call sign or aircraft registration marking
Pressure Altitude	Up to 30000ft in 25ft increments in-flight / on-ground
Flight Status	Reports the available data and means by which the transponder can report.

Figure 10: Transmitter receiver



7. Maintenance

7.1. Periodic Maintenance

The KTX2 Mode-S Transponder has been designed and manufactured to allow “on condition maintenance”. This means that there are no periodic service requirements necessary to maintain continued airworthiness, and no maintenance is required as long as it does properly perform its intended function. When service is required, a complete performance test shall be accomplished following any repair action. Repairs shall only be carried out in accordance with TQ-Systems GmbH service procedures.

7.2. Repair

Only exchange and flat repair of the equipment is permitted. In case of equipment malfunction, the unit must be sent to the manufacturer. Refer to section “1.2 Customer Service”.

7.3. Cleaning

Clean the display only with, lint-free cloth and an eyeglass lens cleaner that is specified as safe for anti-reflective coatings.



Operation and Installation Manual
KTX2 Mode-S Transponder

Doc.-No: KTX2.A-MAN.en
Revision 0101

TQ-Systems GmbH

Support E-mail: support.ktx@tq-group.com

Internet: www.tq-avionics.com